

ELECTRONIC CONTROL CATALOG

Copyright SOMFY SYSTEMS, INC.

All rights reserved. No part of this catalog may be reproduced in any manner, stored in a retrieval system, or transmitted in any form, or by any means, electronic, mechanical, photocopying or otherwise without the prior written permission of SOMFY SYSTEMS, INC.

Printed in U.S.A. 3/02



MOTORIZATION CONCEPTS

2

GUIDELINES FOR SELECTING SOMFY SYSTEMS

2

ELECTRONIC PRODUCTS

AC Motor Control

3

DC Motor Control

5

INTERFACING AND INTEGRATING

6

**SWITCHES**

7

TYPICAL AC WIRING DIAGRAM

8

DECORATOR SWITCH LINE

9

DECORATOR IGC SWITCH

10

DECORATOR RTS SWITCH

12

CHRONIS RTS TIMER

13

INTELLIS 24 HOUR TIMER

14

INFRARED SWITCH

16

OUTDOOR PLUG-IN SYSTEM

18

DIGITAL KEYPAD

19

KEY SWITCHES

20

**INDIVIDUAL AND GROUP CONTROLS**

21

INDIVIDUAL-GROUP CONTROL FOR DC MOTORS (IGC-DC)

22

DC-5 CONTROL

24

GROUP CONTROL SYSTEM II (GCS II)

26

INDIVIDUAL-GROUP CONTROL I (IGC and IGC/3N1)

28

INDIVIDUAL-GROUP CONTROL II (IGC II and IGC II/3N1)

31

IGC SUBGROUP CONTROL

34

MODULE SYSTEM

35



SUN AND WIND CONTROLS

37

DECORATOR SOMFY-MATIC™ (DSM)	38
DECORATOR SOMFY-MATIC™ OUTDOOR PLUG-IN SYSTEM	40
DECORATOR COMFORT CONTROL (DCC)	42
WIND-A-MATIC II	44
EOLIS RECEIVER	46
SOLIRIS RECEIVER	48
TELIS SOLIRIS TRANSMITTER	50
EOLIS & SOLIRIS RTS SENSORS	51

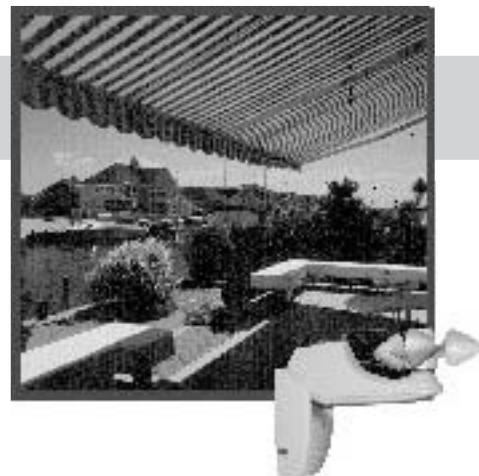

REMOTE CONTROLS

53

CENTRALIS	54
RTS 25 DC	56
TELIS 1 & 4 CHANNEL TRANSMITTERS	57
HRC-RF	58
MULTI-CHANNEL INFRARED CONTROL (MCIR)	60
HRC-IR	62
IRS 300 INFRARED CONTROL FOR DC MOTORS	64
WIRELESS COMMAND II	66
SINGLE MOTOR REMOTE	68
3N1 REMOTE CONTROL	71



ACCESSORIES AND SPECIAL APPLICATIONS

73

RS 232 INTERFACE MODULE	74
MULTI SWITCH COMMAND	75
SYNCHRONIZING CONTROL	76
FABRIC TENSION SYSTEM (FTS)	78
LT28 STALL SENSOR	79
ILT MOTOR CONTROLS	80
LON CONTROLS	82
ACCESSORIES	84

DC Transformers, Drapery Motor Controls, Motor Tester Cable, Modular Cable, IGC CableTester, Electrical Boxes

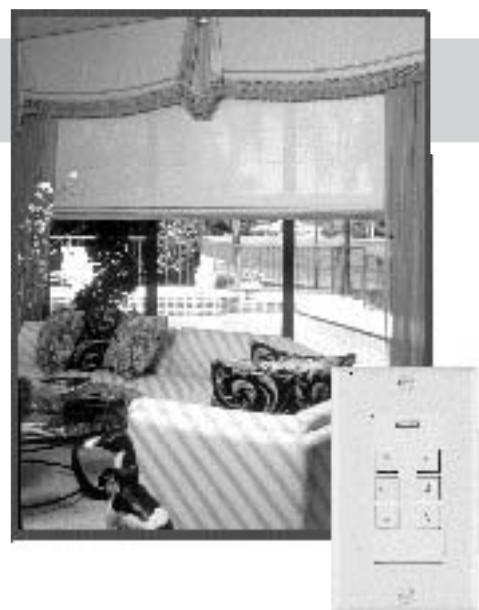

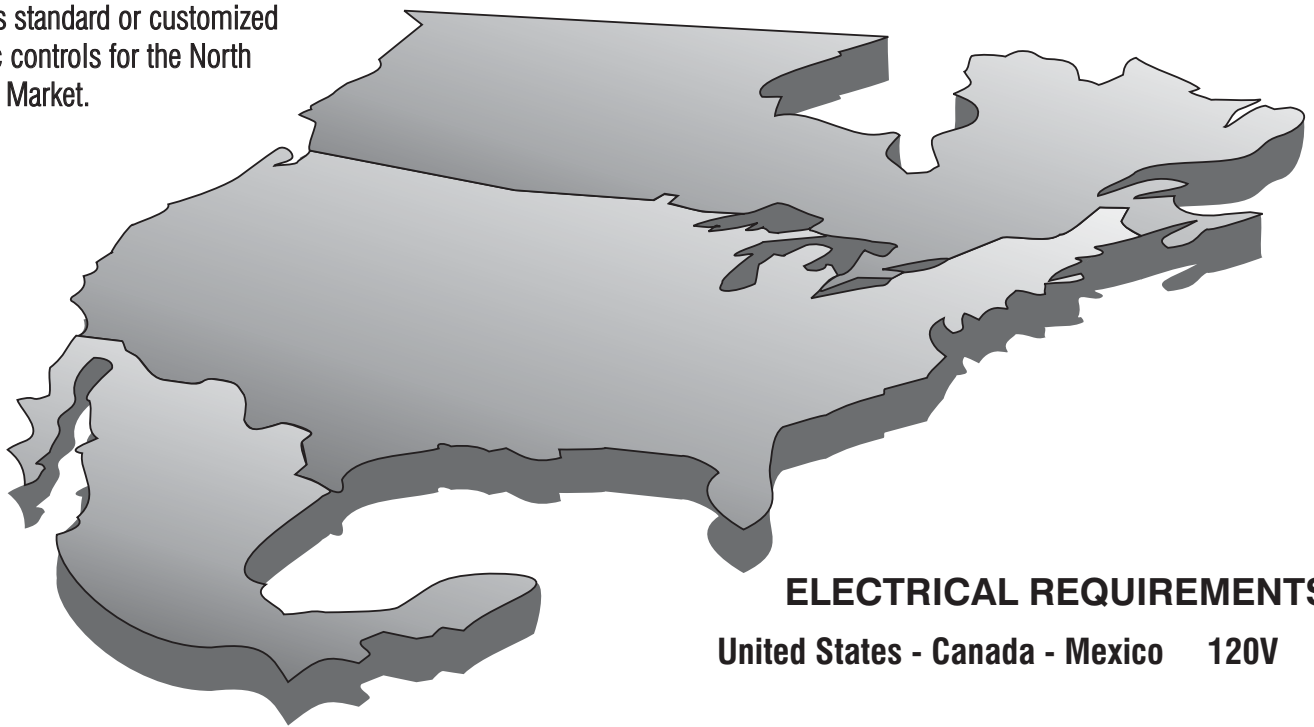

SOMFY is the world's largest manufacturer of tubular motors. For over 25 years, engineers at SOMFY have been designing motors and controls for the retractable awning, rolling shutter, interior window treatment, projection screen and other markets with a commitment to providing the highest level of quality and safety in the industry. Today our motor controls are rigorously tested both here in the U.S. and at our World Headquarters in Cluses, France, where Underwriters Laboratories has certified SOMFY's test facility. Underwriters Laboratories, or UL, is an independent, non-profit organization in the United States with the sole purpose of evaluating the safety of electrical products. SOMFY's selection as a UL Client Test Facility is further evidence of our dedication to providing the finest products on the market. SOMFY SYSTEMS, based in Cranbury, N.J. offers standard or customized electronic controls for the North American Market.

**ELECTRICAL REQUIREMENTS**

United States - Canada - Mexico 120V 60 Hz

NORTH AMERICAN STANDARD

SOMFY UL approved controls can be found in UL File No. E160923

Notice: In an ongoing effort to be the leader in our industry, motor controls are occasionally subject to modification or discontinuation. SOMFY SYSTEMS reserves the right to change, update, or improve this document without prior notice.



Guidelines for Selecting SOMFY SYSTEMS Electronic Products

Installations of dual direction motors require flexibility of control and compatibility not only with decor, but also with security, lighting, and environmental control systems. All SOMFY SYSTEMS control products are designed to maximize utility and aesthetics, as you will see in the catalog pages that follow. This section will help in selecting the devices that fit your application best by explaining the general options in a motor control system.

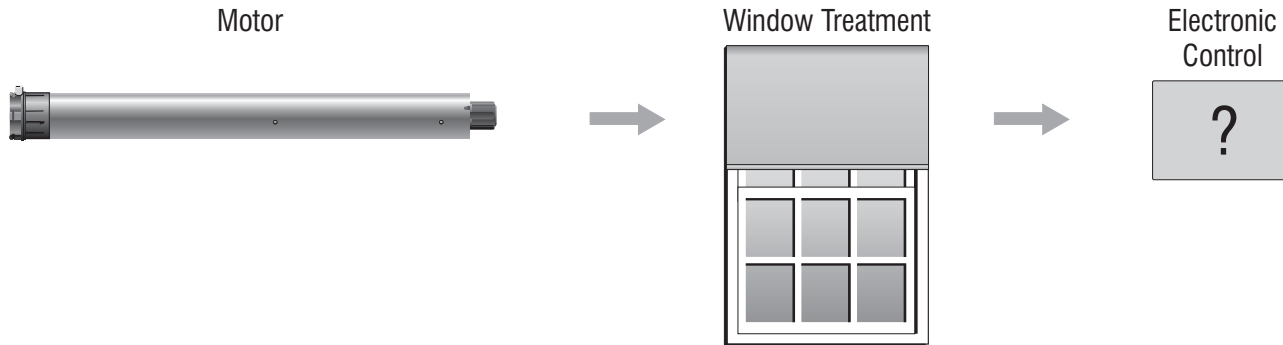

Why Do I need Motor Controls?

The design characteristics of an AC dual direction tubular motor which enable it to generate enough torque to raise awnings, shutters or shades, require several considerations in the design of its control circuit. First, these motors cannot be wired in parallel from a single switch as lighting fixtures can. There must be a SOMFY control device which prevents electrical feedback through the motor capacitor, such as a Group Controller or a network of Individual-Group controls. Second, one SOMFY motor cannot be controlled from several locations (switches) without a control device to build priorities among switch signals. A SOMFY Multi-Switch Command (MSC) or an Individual-Group Control (IGC) would apply here.

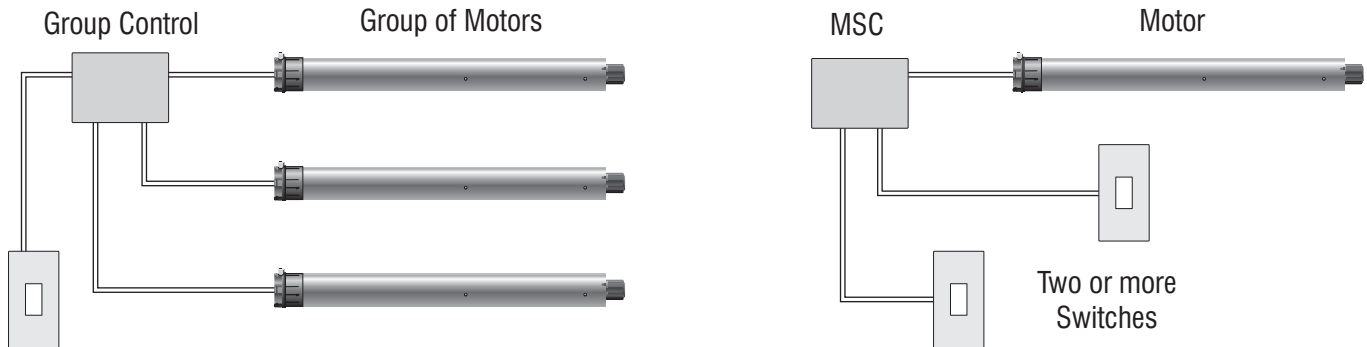

What is 'low voltage control' or 'low voltage input'?

Low voltage control refers to switch and automatic control inputs which interface with 120 volt AC motor controls. Low voltage (usually 12 volts DC) provided by the motor controller supplies the switches and allows for a more flexible system design than can be found with a 120 VAC or 'line voltage' switch network. Low voltage wiring eliminates some of the hazards of line voltage, and is accomplished safely with inexpensive low voltage rated wire or modular cable.

DC motors, by definition, include low voltage controls. The wiring requirements for DC motors are different than described above, and will be discussed later in this section.

MOTORIZATION CONCEPTS (Cont'd)

AC MOTOR CONTROL

Switches

Switches are the most common interface between the user and the motor or motor controller.

SOMFY offers a line of elegant switches made exclusively for motor control. These switches feature up, down, and stop positions in both momentary and maintained configurations for hardwired AC control of a single motor. Momentary switches will continue to drive the motor in a given direction as long as that switch direction is depressed, or until the motor reaches its limit in that direction.

Maintained switches can be pressed and released and the motor will travel to its limit in the chosen direction. If you are required to control a single motor from two or more locations, it will be necessary to have all the switches interface with a SOMFY Multi-Switch Command unit. If one switch is required to control two or more motors, you will need to review the Group Control products.

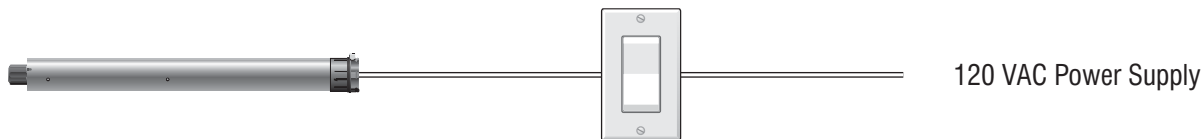

Group Control

Group Control is the movement of 2 or more motors from a single switch.

The SOMFY Group Control System allows for simultaneous control of an unlimited number of motors. At the heart of the Group Control System is the GCS-II which controls up to 4 motors as a group. The GCS-II accepts low voltage inputs from SOMFY's own line of switches and it can be activated by building lighting or automation systems. In addition, SOMFY offers sun and wind controls for the GCS-II as well as a radio remote control option. Multiple GCS-II's can be linked together and operated by a single "master" switch. If, however, both group control and individual control of a number of motors is necessary, SOMFY offers a line of Individual-Group Control products.

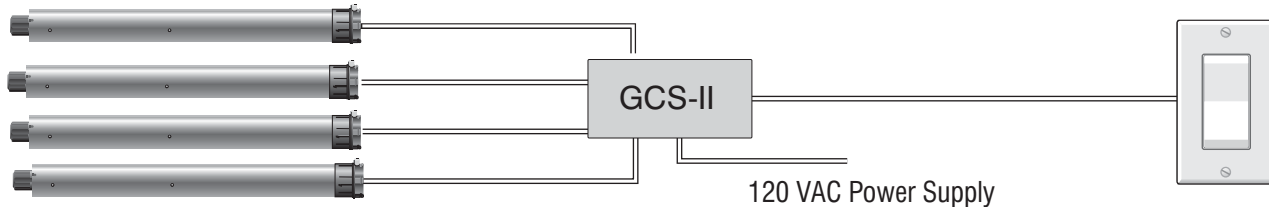

Individual-Group Control

Individual-Group Control includes all the functionality of Group Control (above) while maintaining the ability to operate each motor individually or in smaller 'sub-groups'.

Under ideal conditions, you would be able to control each of a number of motors individually but also maintain the capability to operate them as a group. SOMFY IGC products make this possible. The IGC is a single motor controller with low voltage individual and group switch inputs. Control options include switches, timers, remotes, lighting controls, and sun and wind control. To gain economies of scale, install the IGC/3N1. The 3N1 is a 3 motor controller with individual inputs for each of the 3 motors and a master switch input to operate all 3 at once. Any number of IGCs and IGC/3N1s can be linked to achieve the ultimate in flexible systems. If remote control is specified, SOMFY offers the IR (Infrared) Switch, which combines the elegance of the IGC switch with the convenience of infrared remote control in a single gang box. In addition, the IGC II and IGC II/3N1 add infrared remote capabilities through an X10 interface.

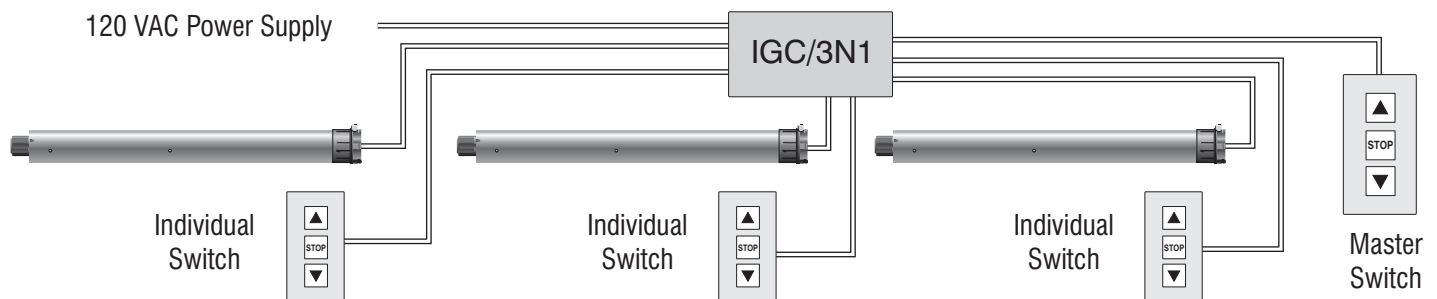

MOTORIZATION CONCEPTS (Cont'd)

Remote Control

Remote Control enhances comfort and convenience, and is GCS and IGC compatible.

To satisfy today's consumers' need for comfort and convenience, SOMFY SYSTEMS offers a complete line of remote control products in both infrared and radio frequencies. Infrared controls are typically less expensive but require the user to be indoors and in line of sight of the infrared receiver. Radio remote control provides a greater range and the signal can be transmitted through walls and floors, so receivers can be mounted out of sight. In both cases, remote control not only adds functionality, but by eliminating wall switches it also relieves some of the wiring burden during installation. Remote control units can be stand-alone for one to three motors, or they can be interfaced with group or individual controls. There is a SOMFY remote control solution for every motor or group application.

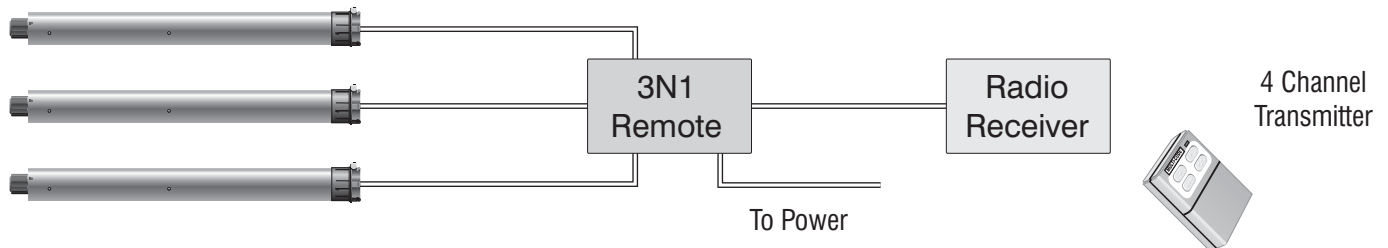

Somfy's newest innovation in Remote Control is RTS Technology, where the radio receiver is built right in the motor. Wiring is minimized during installation, as only power to the motor is required. With the Inteo line of controls, standard LT motors can be controlled side by side with RTS Motors, using the Telis Transmitters.

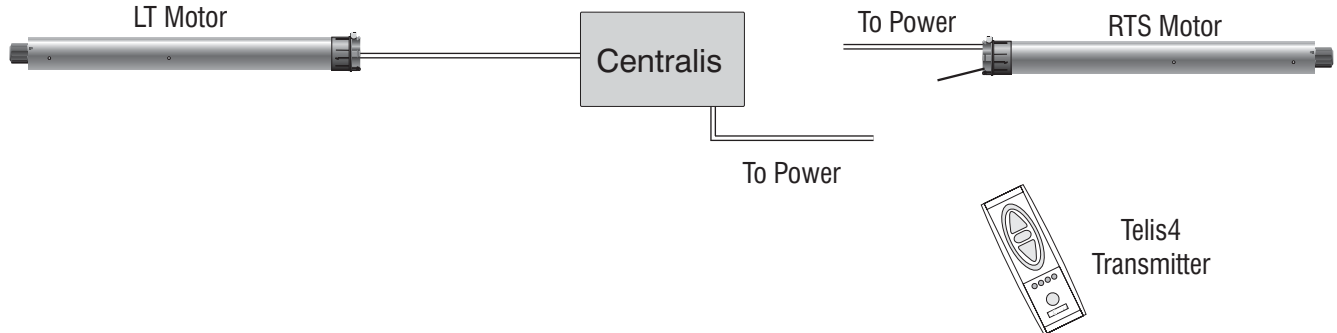

Automatic Controls

Motors can be controlled automatically based on the sun, wind, or time of day.

The ultimate motor control is a SOMFY SYSTEMS automatic controller. Based on the intensity of the sun, the wind, or just the time of day, intelligent environmental controls and timers can position a single motor or a whole house full even when there's no one home. These controls are engineered to be compatible with the entire line of SOMFY products, and can be integrated into a system with manual switch stations and remote control. Automatic controls are available with standard installation features or in an outdoor plug-in system, reducing the wiring requirements for outdoor (awning) applications.

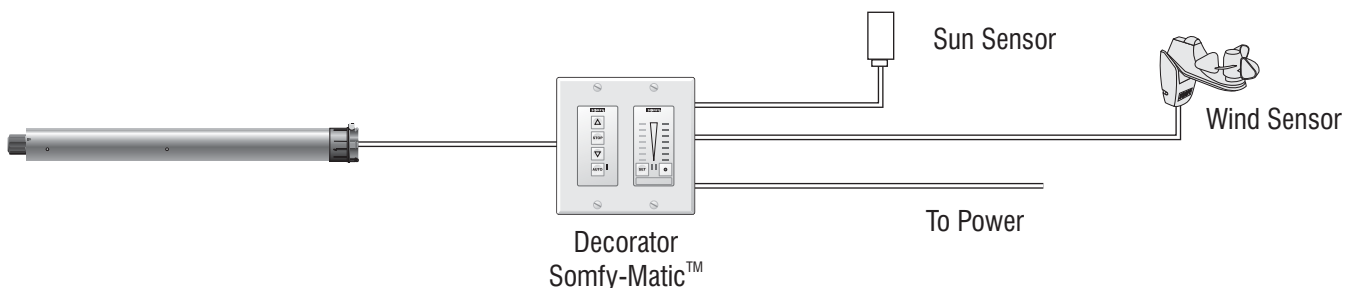

MOTORIZATION CONCEPTS (Cont'd)

DC MOTOR CONTROLS

The use of DC motors eliminates some of the complexities required for controlling AC motors. SOMFY SYSTEMS line of DC motor controls includes Switches, Individual-Group Controls, and Infrared Remote Controls. Keep in mind that whenever DC motors are called for, a transformer must be specified to supply power to the system.

Switches

DC motors can be wired in parallel from a single switch. One or more motors can be controlled from a single low voltage switch. SOMFY's switches feature momentary or maintained operation, and are offered in rocker and toggle styles.

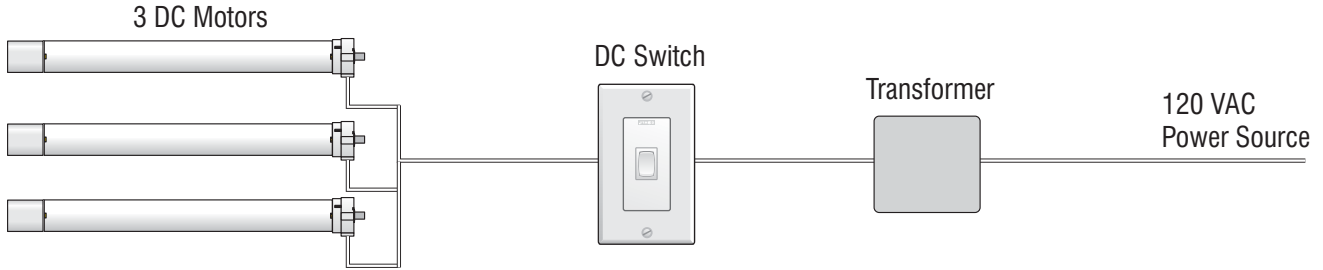

Individual-Group Control

While a simple switch can control a small group of DC motors, the IGC-DC is necessary for preserving both individual and group control. Each IGC-DC controls from one to five motors with the push of a single switch. This control also offers a master line which can be linked to other IGC-DC's, and all can be operated at once from a master switch. The IGC-DC features Up, Stop and Down buttons. A typical example below shows three individual IGC-DC switches, each operating a different set of motors while total control of all motors is achieved by linking all systems to a master switch.

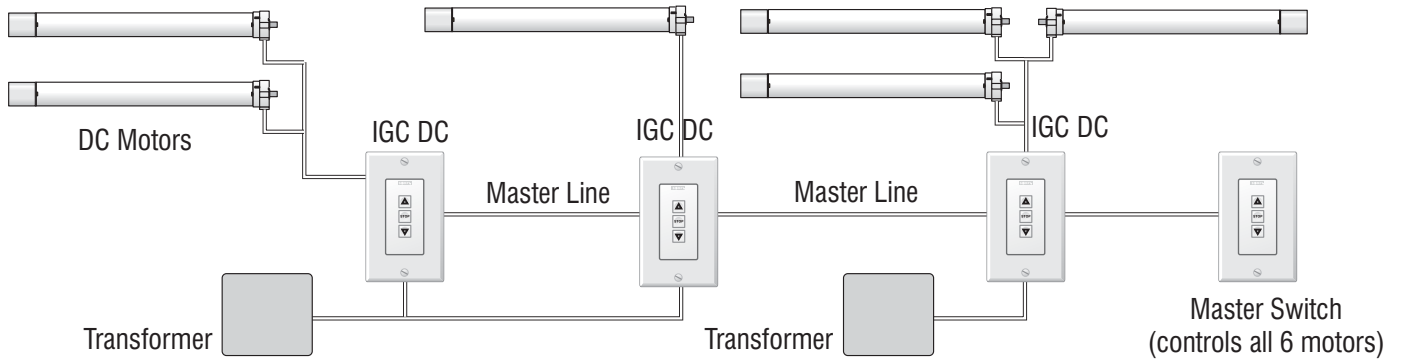

Infrared Remote Control

IR control provides a convenient method of operating DC motors. With the IRS 100 and IRS 300, up to 3 motors can be controlled simultaneously from a single hand held remote. The IRS 300 offers an additional tilt feature for horizontal blinds.

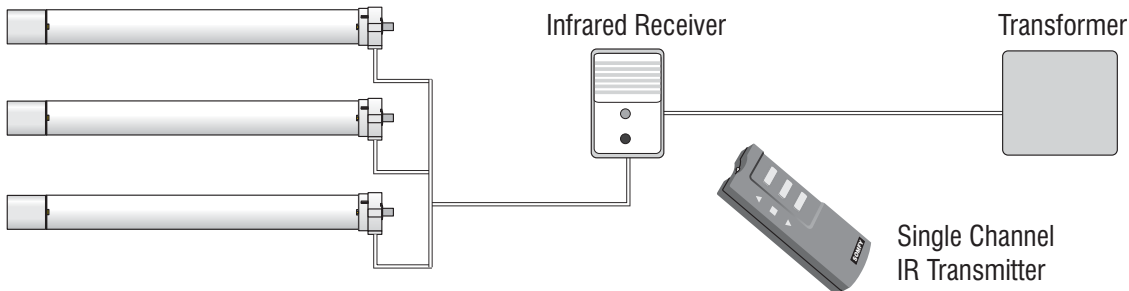

MOTORIZATION CONCEPTS (Cont'd)

INTERFACING and INTEGRATING

In today's world of increasing technology, we are automating our lifestyles more and more to save time and gain convenience. SOMFY is committed to providing the best products and service to systems integrators. Most of SOMFY'S controls have low voltage interface points for control by outside home automation or lighting systems. These details are located throughout the catalog pages.

SOMFY SYSTEMS also has an RS232 module that will communicate between a PC and SOMFY controls. For more complex systems, SOMFY offers a line of LON compatible controls that operate with our ILT motor. This system has the ability, through software, to monitor outside light conditions in order to optimize indoor lighting and temperature.

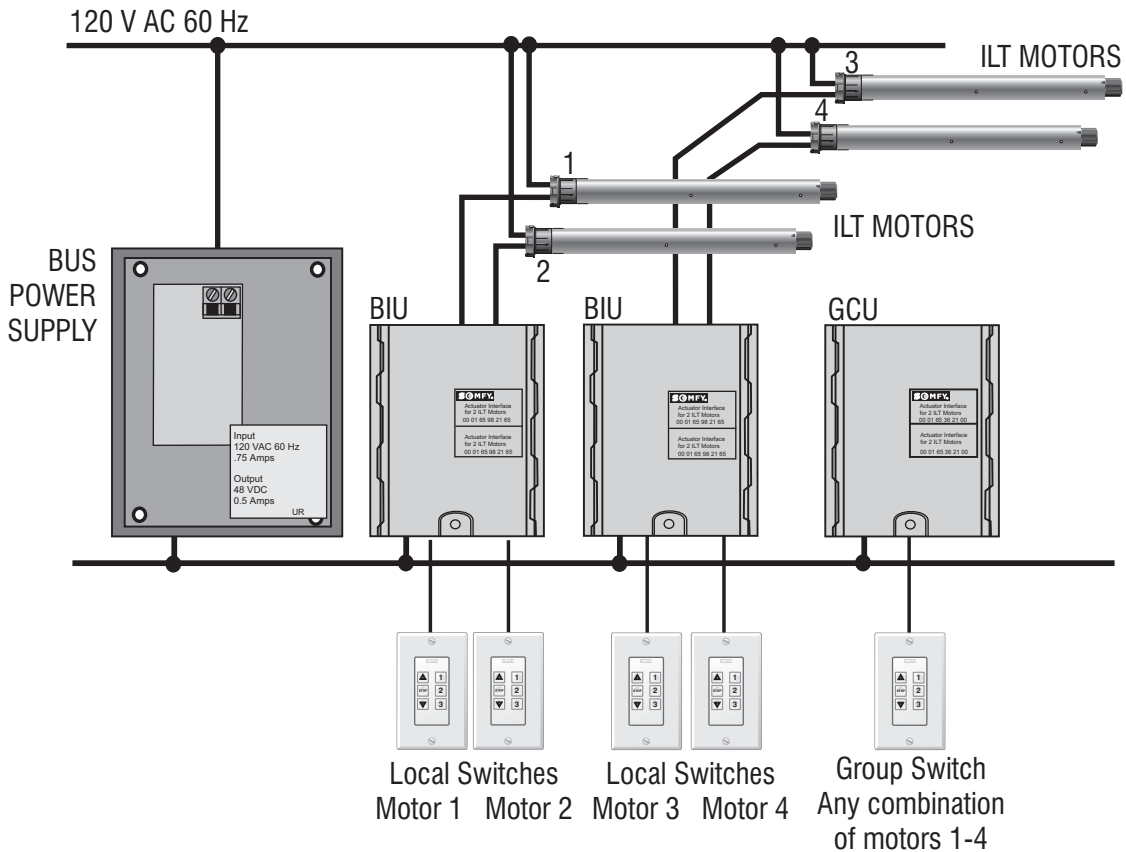
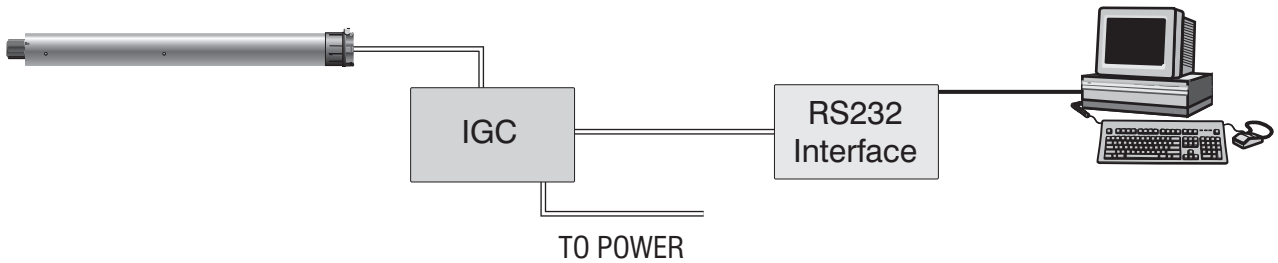

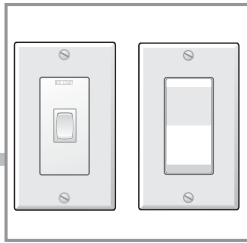

Decorator Switches

8

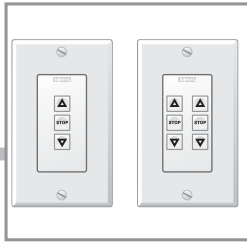
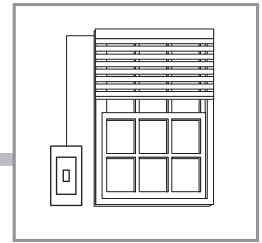

Decorator IGC Switches

10

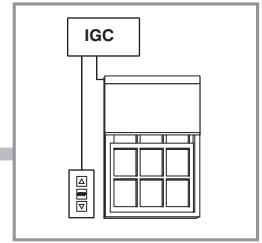

*Decorator RTS Switch
Chronis RTS Timer*

12
13

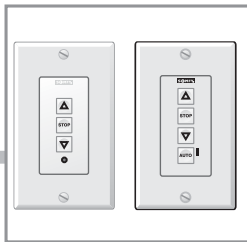
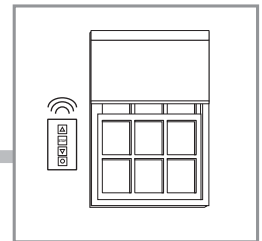

*Intellis Timer
Infrared Switch*

14
16

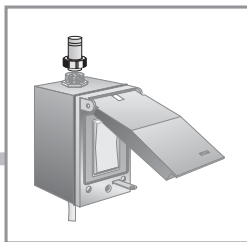
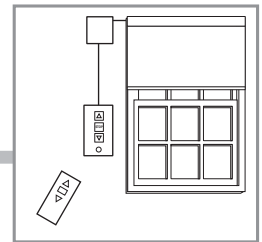

Outdoor Plug-in System

18

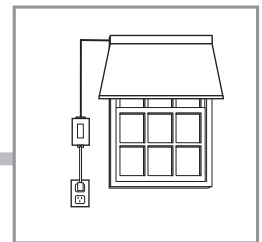

Digital Keypad

19

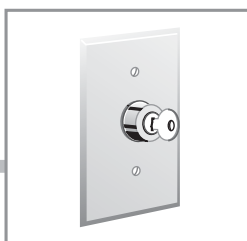
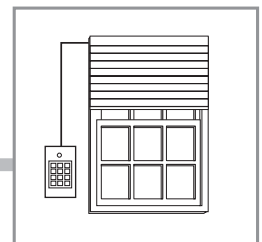

Key Switches

20

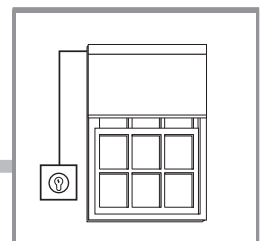

DECORATOR SWITCH LINE

DESCRIPTION

SOMFY's Decorator Switches provide easy control of all types of motorized window applications. Their rugged yet elegant design complement any decor. They are available in white and ivory and, with the exception of the standard DC Switches, feature a maintained or momentary model.

NOTE: Switchplates must be ordered separately

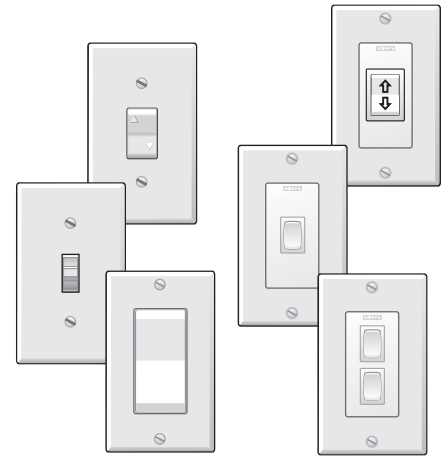

APPLICATIONS

ONE MOTOR / SINGLE POLE SWITCH

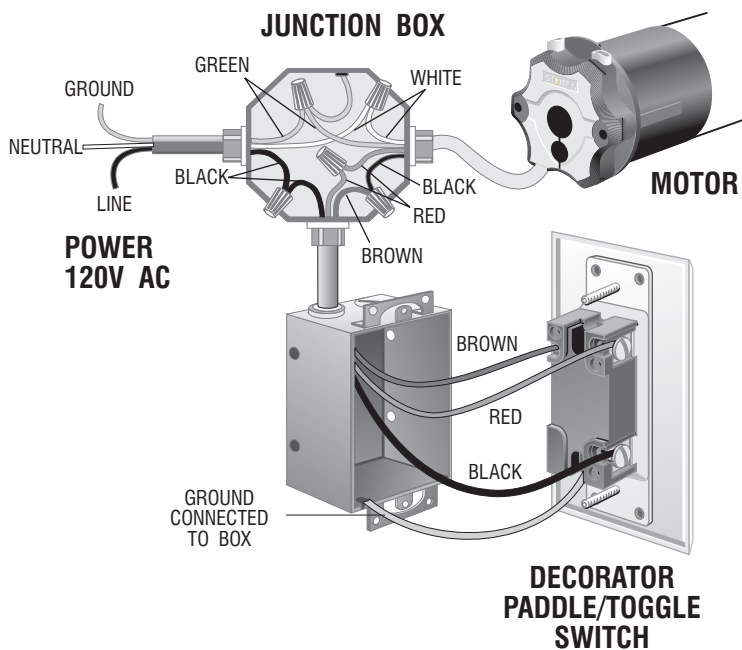

TWO MOTORS / DOUBLE POLE SWITCH

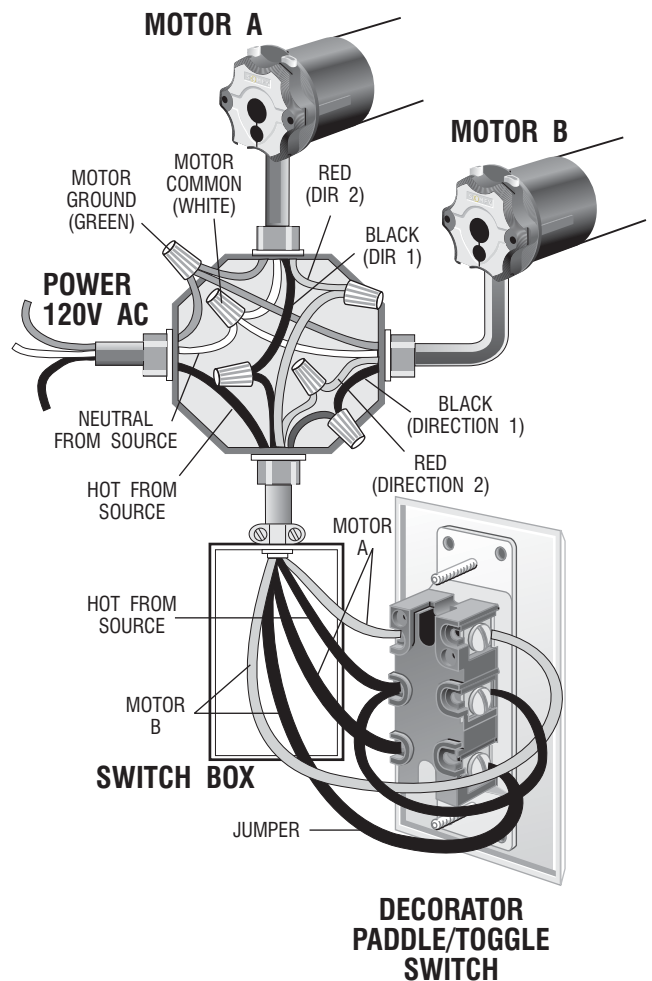

CAUTION: Before proceeding with the line voltage wiring instructions, the up and down limits of each motor should be set using the SOMFY tester cable (Cat. No. 6020086). Refer to the limit switch instructions packaged with each SOMFY motor for more information.

DC DECORATOR ROCKER SWITCHES

The DC Decorator switch line is designed for DC motorized interior window treatment applications. Both single and double switch stations are single pole, double throw, with center off. The soft contours and coloring of the switches will complement any decor, and they are designed to fit into a standard single gang electrical box.

Description	Catalog Number
DC Rocker Switch (Maintained - Single)	6300922
DC Rocker Switch (Maintained - Double)	6300923
DC Rocker Switch (Momentary - Single)	6300967
DC Rocker Switch (Momentary - Double)	6300968



Cat. No. 6300922



Cat. No. 6300923

STANDARD DC SWITCHES

SOMFY's three-position maintained DC toggle and rocker switches provide convenient fingertip control of any DC controlled window treatment in your installation. These switches feature up, down, and center stop positions, and are the maintained type. They mount easily into a standard single gang box.

Description	Catalog Number
DC Rocker Switch (White)	6120694
DC Rocker Switch (Ivory)	6120695



Cat. No. 6120694

5 POSITION DC SWITCHES

SOMFY's five position DC switches are designed to give both maintained and momentary outputs. This is especially useful for tilt control with horizontal blinds. These switches are designed to mount in a single gang electrical box.

Description	Catalog Number
5 Position 2 Speed DC Rocker Switch	6120742
5 Position DC Rocker Switch	6300951



Cat. No. 6120742



Cat. No. 6300951

DECORATOR AC SWITCHES

SOMFY'S AC switches are designed for window treatments using SOMFY's AC motor line. The 5 position switches offer both momentary and maintained outputs, with center off. This is especially useful for tilt control with horizontal blinds. These switches mount in a single gang electrical box.

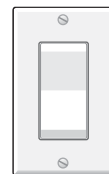

Cat. No. 6120727



Cat. No. 6120746

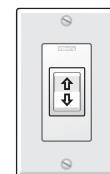

Cat. No. 6300924



Cat. No. 6120144

Description	Catalog Number	Description	Catalog Number
5 Position AC Decorator Rocker Switch	6300924	Rocker Switch Kit w/Princess Plate (Maintained - Ivory)	6120144
Decorator Paddle Switch (Maintained - Ivory)	6120726	Rocker Switch Kit w/Princess Plate (Maintained - White)	6120688
Decorator Paddle Switch (Maintained - White)	6120727	Rocker Switch Kit w/Princess Plate (Momentary - Ivory)	6120155
Decorator Paddle Switch (Momentary - Ivory)	6120734	Rocker Switch Kit w/Princess Plate (Momentary - White)	6120689
Decorator Paddle Switch (Momentary - White)	6120735	Rocker Switch Kit w/Standard Plate (Maintained - Ivory)	6120403
Decorator DPDT Paddle Switch (Maintained - White)	6120728	Rocker Switch Kit w/Standard Plate (Maintained - White)	6120404
Decorator DPDT Paddle Switch (Maintained - Ivory)	6120729	Rocker Switch Kit w/Standard Plate (Momentary - Ivory)	6120414
		Rocker Switch Kit w/Standard Plate (Momentary - White)	6120415
Decorator Toggle Switch (Maintained - Ivory)	6120745	Rocker Switch Kit w/Alum. Std. Plate (Maintained - White)	6120405
Decorator Toggle Switch (Maintained - White)	6120746	Rocker Switch Kit w/Alum. Std. Plate (Momentary - White)	6120416
Decorator Toggle Switch (Momentary - Ivory)	6120747		
Decorator Toggle Switch (Momentary - White)	6120748		

DECORATOR IGC SWITCH

DESCRIPTION

The Decorator IGC switch line is designed for use with SOMFY's IGC and IGC/3N1 controls. This switch features a 6 pin modular connector which takes advantage of modular cable to connect it to a motor controller. The IGC Switch can be used for individual or group control. Both single and double switch stations come in white and ivory, and feature UP, STOP and DOWN buttons. The soft contours and neutral colors complement any decor.



MECHANICAL SPECIFICATIONS

Overall Dimensions: L: 4 1/2 in. W: 2 3/4 in. D: 1 1/2 in.

Installs in a standard single gang electrical box.

The Decorator IGC Switches are compatible with these SOMFY Products:

IGC	Cat. No. 6300717
IGC/3N1	Cat. No. 6300719
IGC II	Cat. No. 6300817
IGC/3N1 II	Cat. No. 6300819
MCIR	Cat. No. 6300885
IGC-DC	Cat. No. 6300843, 6300840
Synchronizing Control	Cat. No. 6300889
DC5	Cat. No. 6300370
HRC-IR	Cat. No. 6300983
HRC-RF	Cat. No. 6300982
Wind-a-Matic II	Cat. No. 6300998

CONNECTION DIAGRAM

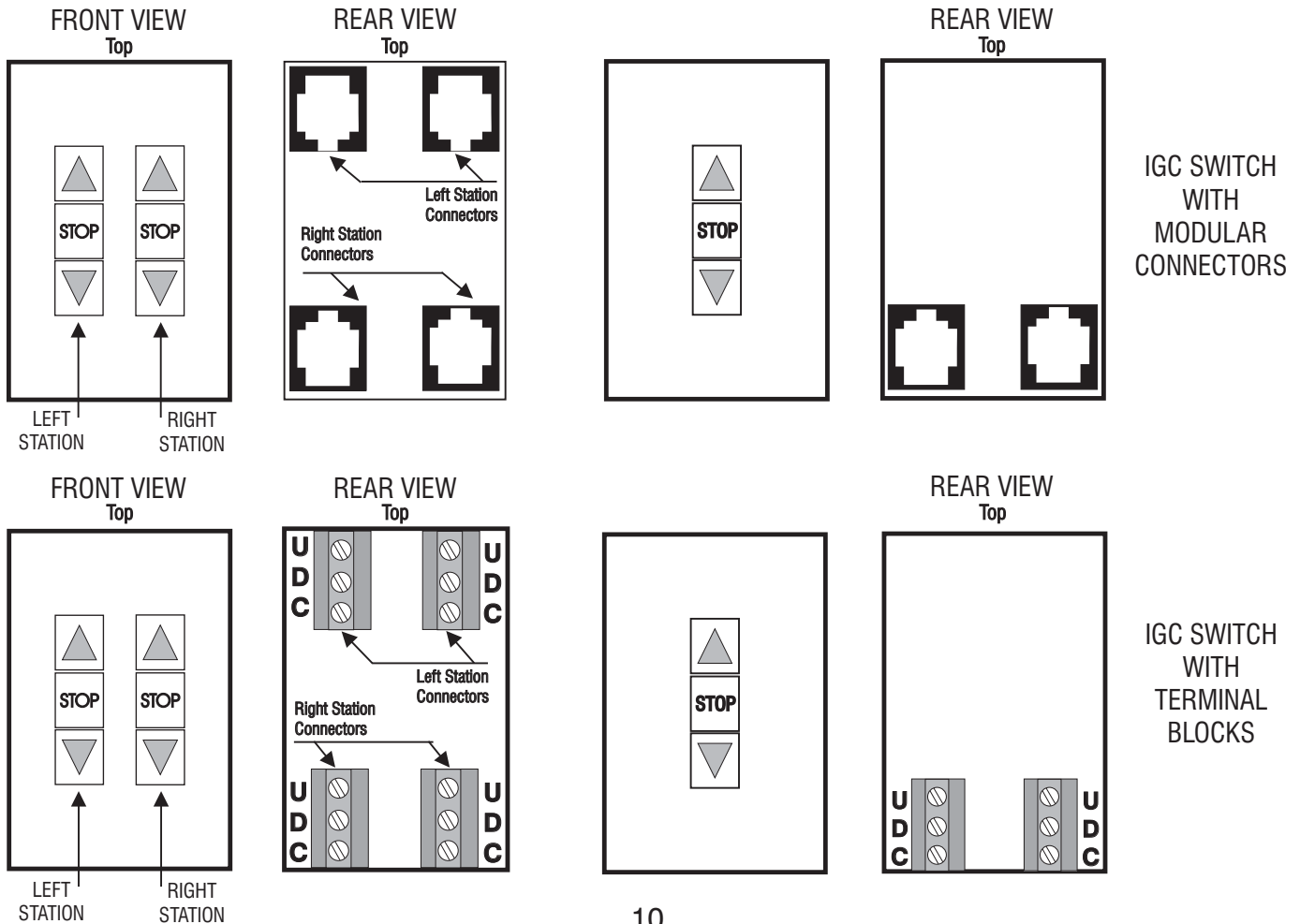

APPLICATION

Below is an illustration of how the Decorator IGC switches are used in conjunction with the SOMFY IGC, IGC/3N1 and the IGC Sub-Group Control to create individual motor, group motor, floor control and master (entire house) control.

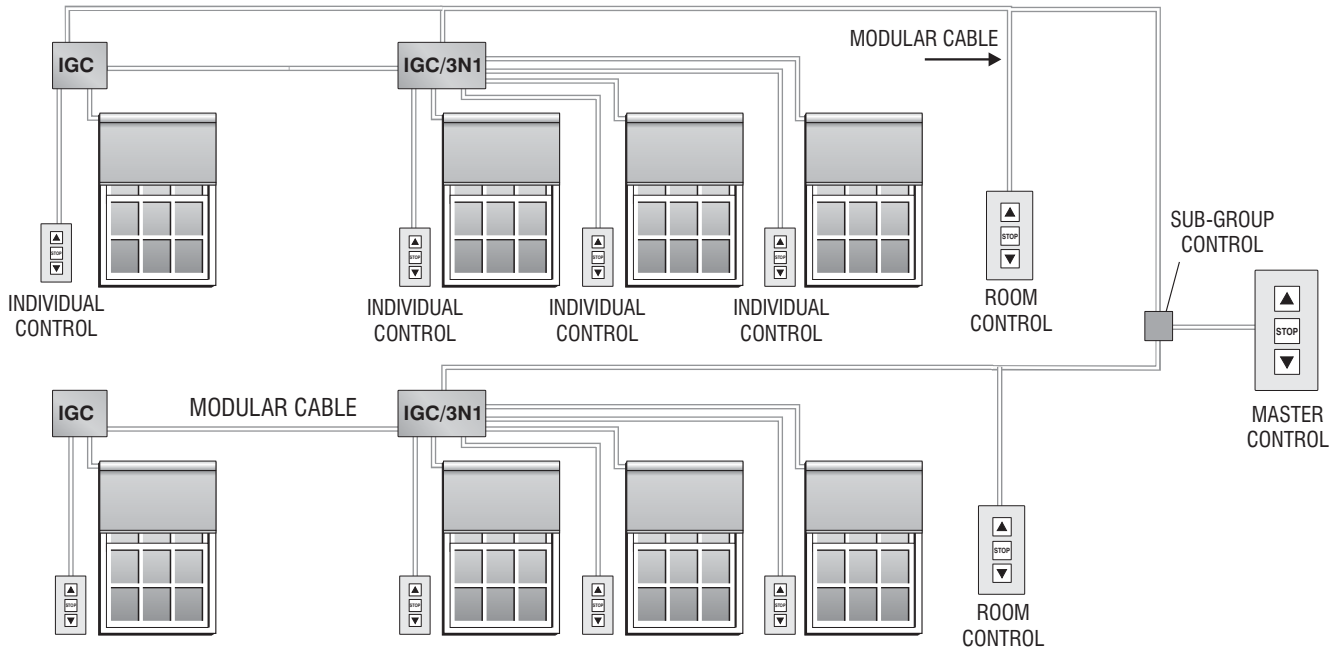

MODULAR CABLE DETAILS

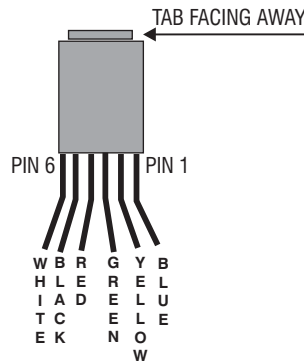
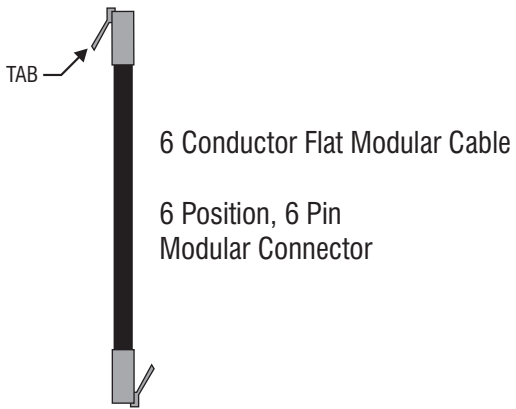

COLOR	PIN NO.	FUNCTION
WHITE	6	UP
BLACK	5	DOWN
RED	4	+12 VDC
GREEN	3	COMMON
YELLOW	2	NOT USED
BLUE	1	NOT USED

ORDERING INFORMATION

Description	Catalog Number	Description	Catalog Number
Single IGC Switch (White)	6300908	Single IGC Switch with Terminals (White)	6300040
Single IGC Switch (Ivory)	6300937	Single IGC Switch with Terminals (Ivory)	6300140
Dual IGC Switch (White)	6300909	Dual IGC Switch with Terminals (White)	6300041
Dual IGC Switch (Ivory)	6300938	Dual IGC Switch with Terminals (Ivory)	6300141

DECORATOR RTS SWITCH

DESCRIPTION

The Decorator RTS Switch (single or four channel) is a wireless radio switch compatible with all the RTS Motors, and externally mounted RTS receivers. It will operate window coverings at a distance with no wiring between the switch and motor or receiver. Commands are transmitted by radio waves at 433.42 MHz.



MECHANICAL SPECIFICATIONS

Overall Dimensions: L: 4 1/2 in. W: 2 3/4 in. D: 1 1/4 in.

Operating Temperature: 41°F to 104°F

Frequency Range (optimal conditions): 65 ft.

Installs in a standard, plastic, single gang electrical box.

ELECTRICAL SPECIFICATIONS

Power: 3V Lithium battery, Cr2430

Frequency: 433.42 Mhz

GENERAL OPERATING INSTRUCTIONS

NOTE: Please Consult RTS Motor or Receiver Instructions for Specific Product Details.

1. Place the RTS Motor or Receiver in Programming Mode as described in the Operating Instructions.
2. Press the programming button on the side of the RTS Switch to program it in the memory of the RTS Motor or Receiver. Be sure the channel is first selected on the four channel model.
3. Pressing the UP button will raise the window covering, while pressing the DOWN button will lower it. To stop the window covering, simply press the STOP button.
4. Pressing the Channel Selector button on the 4-Channel Switch will sequence through the channels. Each LED will light to indicate the channel selected. The Master or 5th channel is indicated when all LEDs are lit.

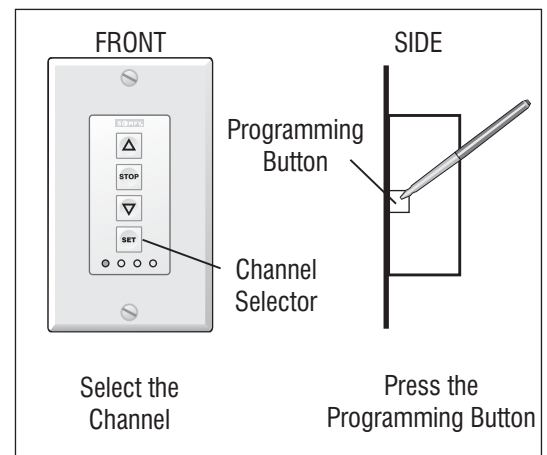

ORDERING INFORMATION

Description	Catalog Number	Description	Catalog Number
Single Channel RTS Switch - White	6301033	Four Channel RTS Switch - White	6301025
Single Channel RTS Switch - Ivory	6301034	Four Channel RTS Switch - Ivory	6301035

CHRONIS RTS TIMER

DESCRIPTION



Catalog No. 6300383

SOMFY's new Chronis RTS Timer is a wireless digital timer compatible with all the RTS Motors and externally mounted RTS Receivers such as the Centralis. It will automatically raise and lower window treatments based on the pre-set time of day. The Chronis can be programmed to operate at the same time each day or different times every day. It has a security function that will raise or lower shades randomly to give the impression of an occupied home. Commands are transmitted via radio, so external wiring is not necessary.

MECHANICAL SPECIFICATIONS

Overall Dimensions: L: 3 1/8 in. W: 3 1/8 in. D: 1 in.

Operating Temperature: 41°F to 104°F

Frequency Range (optimal conditions): 65 ft.

ELECTRICAL SPECIFICATIONS

Power: 2 1.5V DC (AAA) batteries

Frequency: 433.42 Mhz

GENERAL OPERATING INSTRUCTIONS

NOTE: Please Consult RTS Motor or Receiver Instructions for Specific Product Details.

1. Place the RTS Motor or Receiver in Programming Mode as described in the appropriate Operating Instructions.
2. Press the programming button on the Chronis, "PROG" will appear in the display. Continue holding the programming button until the RTS Motor or Receiver confirms it is memorized.
3. Program the UP and DOWN times for each day of the week, according to the Chronis operating instructions. The Chronis will automatically raise or lower the window treatments at the set time.
4. To manually operate the shades, press the UP button to raise the window covering, or press the DOWN button to lower it. To stop the window covering, simply press the STOP button. Intermediate stop positioning (IP) can also be activated. See instruction manual for details.

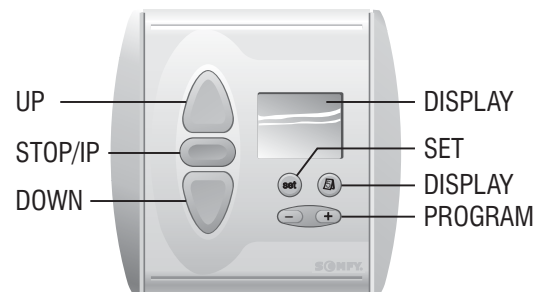

INTELLIS 24 HOUR TIMER

DESCRIPTION

IntelliS is an easy-to-use timer for SOMFY motors. Each day, IntelliS will automatically raise or lower window treatments at a specified time. It is compatible with SOMFY's IGC and GCS-II controls to operate different combinations of individual and groups of window treatments. There is also a model that will operate a motor directly. With the included bracket, the IntelliS Single Motor easily mounts next to existing light switches. Programming is simple, with no confusing displays or rotary dials.

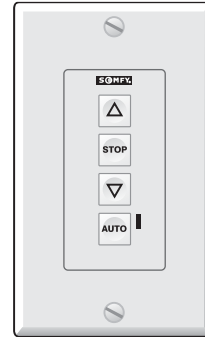

With just the push of a button, IntelliS is in control.

MECHANICAL SPECIFICATIONS

Overall Dimensions: L: 4 1/2 in. W: 2 3/4 in. D: 1 1/4 in.

Installs in a standard single gang electrical box.

ELECTRICAL SPECIFICATIONS

Voltage Rating:

Single Motor

Input 120 VAC +/- 10% 60 Hz
Output 120 VAC 5A 1/4 HP

IGC/GCS

Input 12-15 VDC 150 MA (supplied by IGC or GCS)
Output 12-15 VDC 150 MA (open collector)

Approvals: The IntelliS Single Motor is UL508 for industrial controls (UL, CUL) where applicable.
Complies with the National Electrical Code (NEC) standard.

PROGRAMMING

IntelliS has two modes - Manual, and Automatic. In Manual Mode, the AUTO light is off and IntelliS functions like a standard SOMFY switch. In Automatic Mode the AUTO light is on, and IntelliS moves window treatments UP once each day and DOWN once each day, at the times you have chosen. To program the IntelliS, simply press the auto button and hold it for approximately 5 seconds, until the AUTO light begins to blink. Continue pressing the AUTO button, then press the button (UP or DOWN) corresponding to the direction you desire the window treatment to move. IntelliS memorizes the action, and will perform the same action at the same time every day. Later, at the time you wish the window treatment to move in the opposite direction, press and hold the auto button for 5 seconds until the AUTO light begins to blink, continue pressing the AUTO button then press the button for that direction. IntelliS is now fully programmed, and will repeat this cycle every 24 hours moving window treatments at the precise times you have programmed.

WIRING DIAGRAM

SINGLE MOTOR

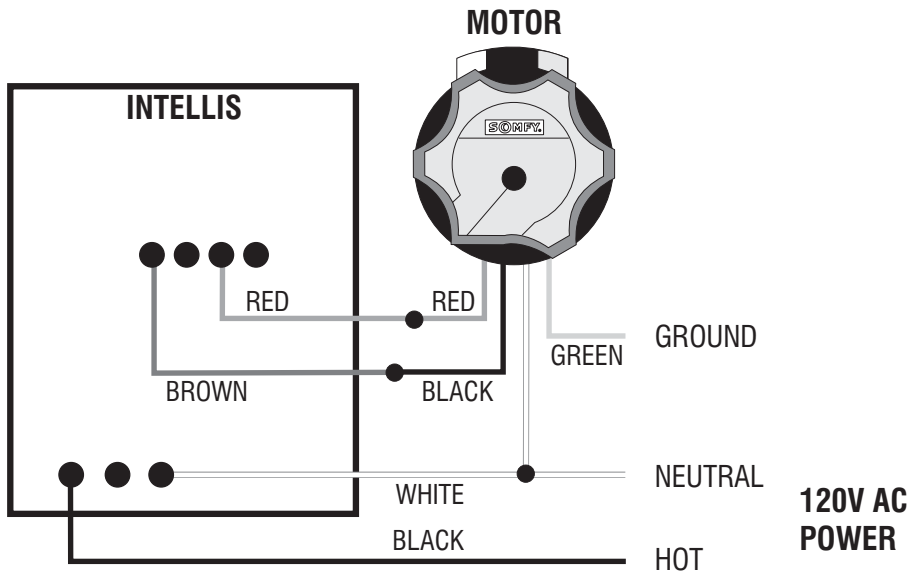

INTELLIS	MOTOR	POWER
RED	RED	
BROWN	BLACK	
	GREEN	GREEN
WHITE	WHITE	WHITE
BLACK		BLACK

Line Voltage installation **MUST** comply with local and NEC codes.

GCS

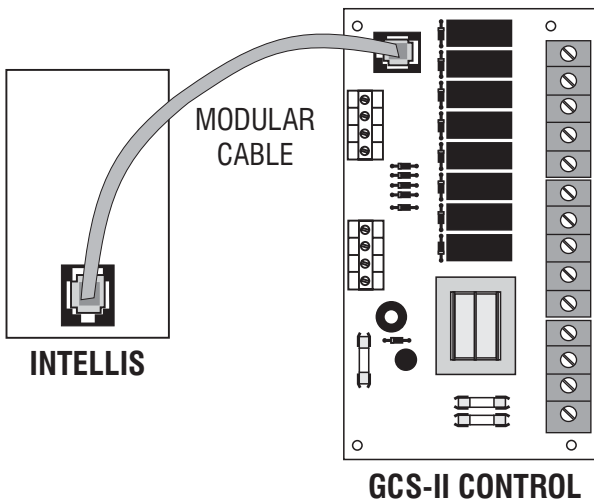

IGC

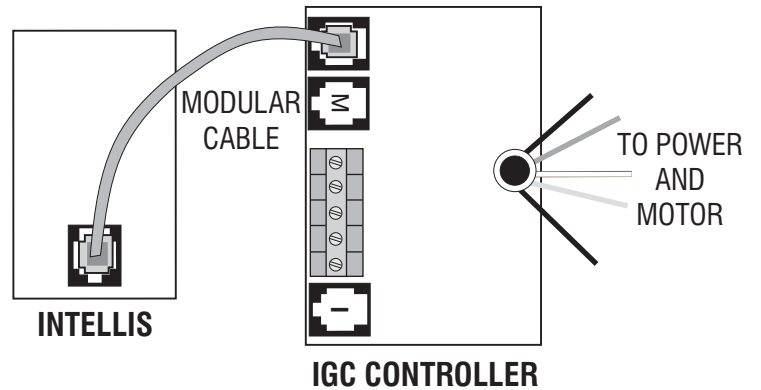

ORDERING INFORMATION

Description

IntelliS-IGC
 IntelliS-GCS
 IntelliS-AC Single Motor

Catalog Number

6300351 (White), 6300352 (Ivory)
 6300361 (White), 6300362 (Ivory)
 6300371 (White), 6300373 (Ivory)

INFRARED SWITCH

DESCRIPTION

The Infrared Switch is designed to provide remote access to many of SOMFY's standard controls. By incorporating an addressable infrared sensor into SOMFY's Decorator IGC switch, individual and master control is possible from a single infrared transmitter. The Infrared switch is compatible with the IGC, GCS-II, IGC-HB, IGC II and MCIR. Up to 8 addresses can be assigned in a variety of configurations (i.e. individual window control, room control, floor control, etc.) to meet the requirements of your customers.



MECHANICAL SPECIFICATIONS

Overall Dimensions: L: 4 1/2 in. W: 2 3/4 in. D: 1 1/4 in.

Typical Range in Optimal Conditions: 20 ft.

Installs in a standard single gang electrical box.

OPERATING PROCEDURES

1. Connect from the modular connector on the IR Switch to the modular connector on the IGC, MCIR or GCS. On the IGC, the switch can be connected to either the Master or Individual ports. Refer to instructions for details.
2. Set the unit address using the rotary switch. Position 1 refers to IR address 1, and position F refers to IR address 15. Position 0 is used only for the single channel transmitter.
3. Mount the IR Switch in a single gang box. Ensure nothing obstructs the sensor opening.
4. Operate each motor in one direction using either the push button switch or the infrared transmitter. If the motor does not move in the correct direction, reverse the red and brown wires at the motor. Please refer to IGC, MCIR or GCS instructions for further information.

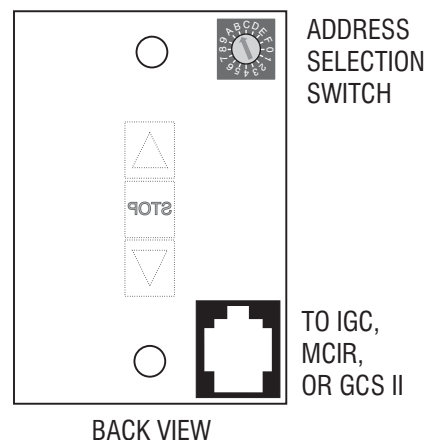

OPTIONS

SINGLE CHANNEL TRANSMITTER: A single motor (address number 0) or group can be operated by pressing either the UP or DOWN buttons on the transmitter. Pressing the center button will stop the motor at its present position.

1 Channel IR Transmitter
Cat. No: 6300879



EIGHT CHANNEL TRANSMITTER: This transmitter has the ability to activate up to 8 motors or groups individually. Press the address of the switch you wish to operate, then the directional command. Pressing a group command (1-4, 5-8, 1-8) and then a direction will activate all switches in the chosen group that are within transmitter range.



8 Channel IR Transmitter
Cat. No: 6300988

TYPICAL APPLICATIONS

INDIVIDUAL CONTROL (One Channel)

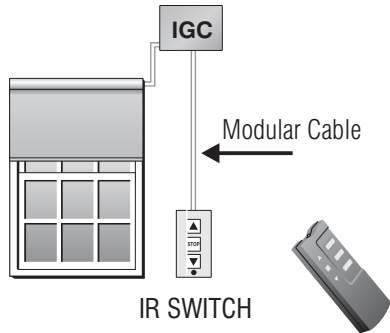

The first illustration shows a single channel transmitter controlling a single motor.

In the second illustration, an eight channel transmitter provides individual and master control. Each switch has a unique address.

Any number of motors can be operated as a group using the IR Switch-GCS version.

INDIVIDUAL AND MASTER CONTROL (Three Channels)

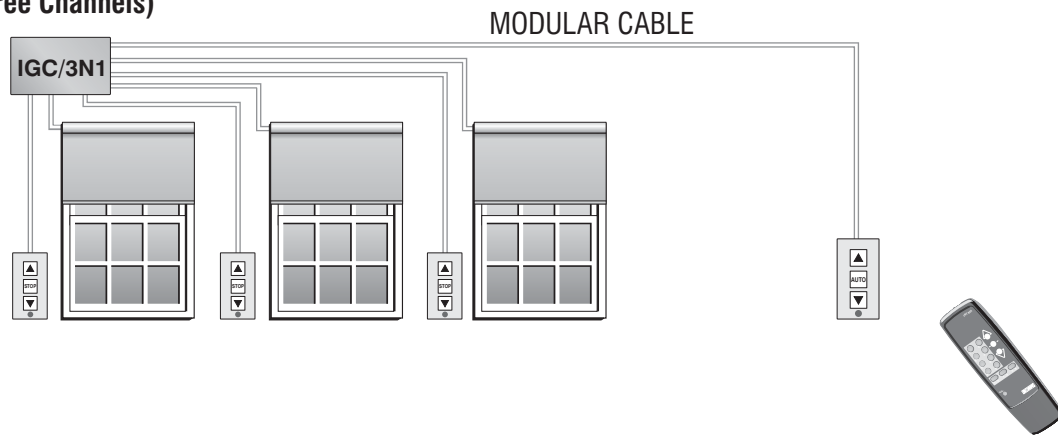

GCS-II WIRING SCHEMATICS

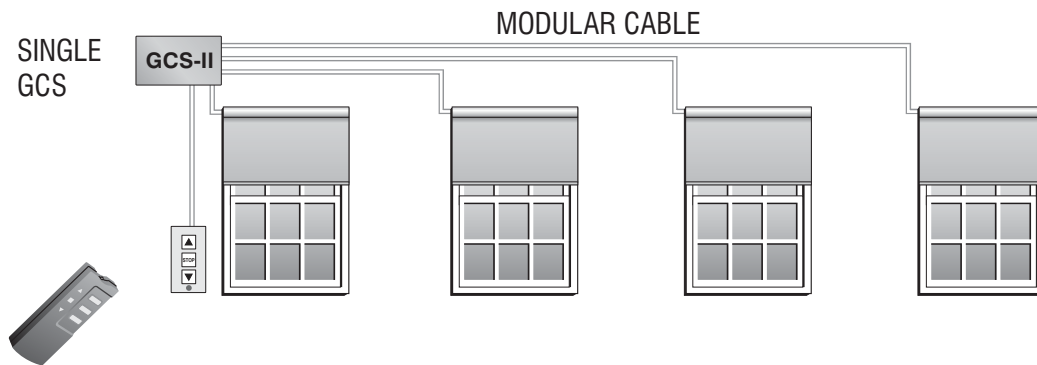

ORDERING INFORMATION

Description

IR Switch - IGC
IR Switch - GCS

Catalog Number

6300050 (White), 6300060 (Ivory)
6300051 (White), 6300061 (Ivory)

Infrared Transmitters

Single Channel Transmitter
Eight Channel Transmitter

6300879
6300988

OUTDOOR PLUG-IN SYSTEM

DESCRIPTION

The Outdoor Plug-in System enables a dealer to install a motorized retractable awning and adjust the limit switches in just one visit! The motor cable plugs directly into the prewired control switch and the detachable power cable plugs into an outdoor receptacle. Custom fit male/female connectors make installation simple.

The system's quick and easy disconnect feature provides the customer with additional safety and security. The end user can easily disconnect it during the winter months, or to prevent tampering while the premises are vacant.

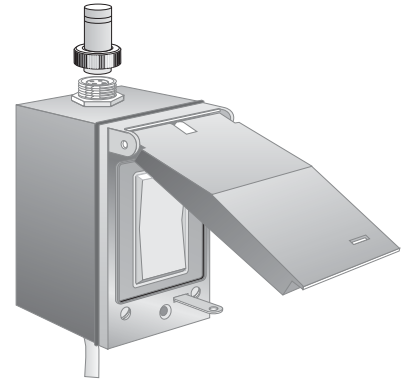

MECHANICAL SPECIFICATIONS

Overall Dimensions: L: 5 ³/₄ in. W: 2 ¹/₂ in. D: 3 in.

Switch comes installed in an outdoor weatherproof box.

APPLICATION

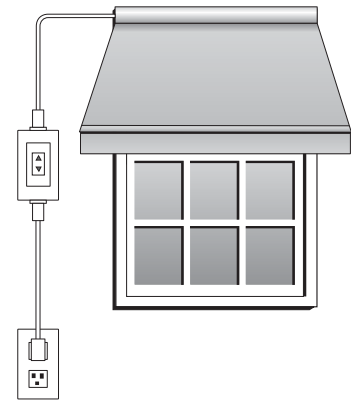

ORDERING INFORMATION

Description

Plug-in Maintained Switch
Plug-in Momentary Switch

Catalog Number

6180291
6180292

6 Ft. Plug-in Power Cord
6 Ft. Plug-in Motor Cable Extension (Optional)
6 Ft. Plug-in Power Cord Extension (Optional)
6 Ft. Plug-in Standard LT Motor Cable
6 Ft. Plug-in LT CMO Motor Cable
6 Ft. Plug-in Cable installed on LT motors
6 Ft. Plug-in Cable Installed on LT CMO

6020387
6020391
6020396
6020505
6020515
6180295
6180296

NOTE: Specify Motor Type When Ordering This System

DIGITAL KEYPAD

DESCRIPTION

The Somfy Digital Keypad is a programmable indoor or outdoor security switch for rolling shutters, doors and grilles. SOMFY's easy to install and simple to use Digital Keypad is the perfect "KEYLESS" solution and a convenient control for motorized rolling shutters and grilles. Designed for security conscious customers, the Digital Keypad features a personal code number to help prevent unwarranted access to their premises. The private entry code can be changed by the end user to ensure limited access or protection should a compromise of security occur.



OPERATING AND PROGRAMMING INSTRUCTIONS

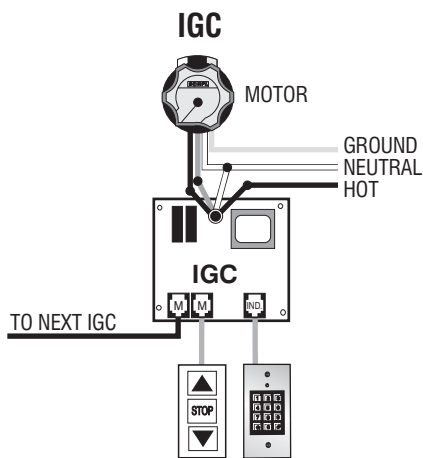

The IGC Outdoor Digital Keypad comes factory programmed with codes for UP, DOWN, and STOP. When the UP code is entered, the keypad will command the IGC to raise the shutter or grille. Similarly, the shutter or grille will lower when the DOWN code is entered.

To keep secure access, the codes can be reprogrammed by following these steps:

KEYPAD ENTRY	FUNCTION
*382436#	Enter programming mode
*193#	Set code length to 3 digits
*11UUU#3#	UUU is the UP code (enter desired digits)
*11SSS#34#	SSS is the STOP code
*11DDD#4#	DDD is the DOWN code
*2301#	Set output pulse width
*2401#	
*99#	Exit programming mode

SINGLE MOTOR REMOTE

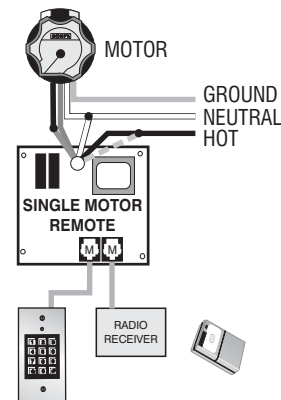

The Digital Keypad for Remote Control comes programmed with a single security code. Every time the code is entered, the Remote Control will sequence through UP, STOP, DOWN, STOP.

Follow these steps to change the security code:

1. Locate the code bank on the decoder module. It has 17 socket positions (*, 0, 1, 2, 3, 4, 5, 6, 7, 8, 9, #) which are printed on the circuit board.
2. Socket positions A B C D E represent the five possible digits of the operating code. Socket position A is the first digit, while E is the last digit of the code.
3. Place one end of a program jumper wire (preinstalled) in socket A and the other end in the desired first digit. Repeat this process for B, C, D, and E. **NOTE:** You may not use the same number twice in the operating code.
4. Attach the decoder to the keypad. Locate the 13 position socket marked **S2** on the decoder board. Align socket S2 with the 13 positions on the keyboard and carefully press the socket onto the pins.

ORDERING INFORMATION

Description	Catalog Number	Description	Catalog Number
Outdoor Digital Key Pad for IGC	6300849	Indoor Digital Key Pad for Remote Control	6300739
IGC Controller	6300717	Outdoor Digital Key Pad for Remote Control	6300740
2 Gang Electrical Box	5670323	Remote Controller	6300690

KEY SWITCHES

DESCRIPTION

SOMFY's line of high-security outdoor Key Switches are protected by a tamper proof cover that cannot be removed without inserting the key. They are available with flush or surface mounting and maintained or momentary switching.

SOMFY also offers several indoor Key Switches for those areas that require enhanced security. These Key Switches include heavy duty and light duty models with either momentary or maintained operation.



WIRING DIAGRAM

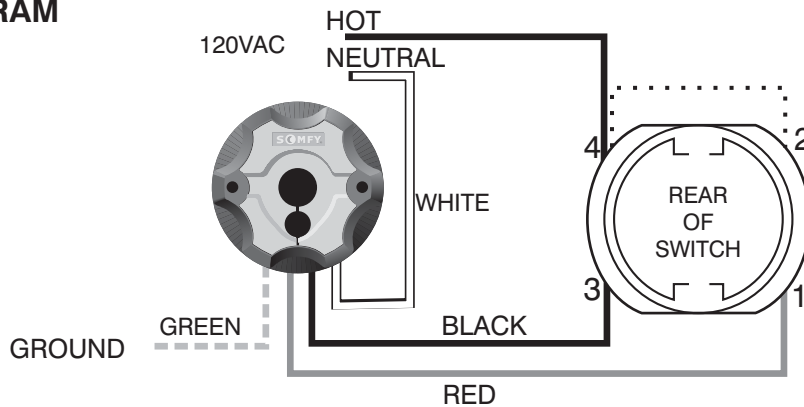

ORDERING INFORMATION

Outdoor Key Switches

	Catalog Number
Heavy Duty Momentary Outdoor Key Switch (surface mount)	6120212
Heavy Duty Momentary Outdoor Key Switch (flush mount)	6120622
Heavy Duty Maintained Outdoor Key Switch (surface mount)	6120223
Heavy Duty Maintained Outdoor Key Switch (flush mount)	6120623
Key Blanks for Outdoor Key Switches	6110761
Rain Hoods for Outdoor Key Switches	6110774
Keyed Alike Key Switch Cylinder	6110772

Note: Upon special request, Key Switches can be keyed alike.

Indoor Key Switches

Heavy Duty Momentary Indoor Key Switch	6120201
Heavy Duty Maintained Indoor Key Switch	6120199
Light Duty Momentary Indoor Key Switch	6120234
DP/DT Momentary Indoor Key Switch	6120582
DP/DT Maintained Indoor Key Switch	6120593
Key for Heavy Duty Indoor Switch	6110425
Key for Light Duty Momentary Indoor Switch	6110293

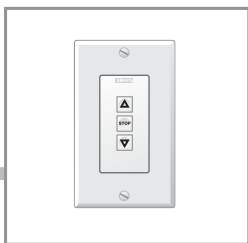

Individual-Group Control for DC Motors (IGC-DC)

22

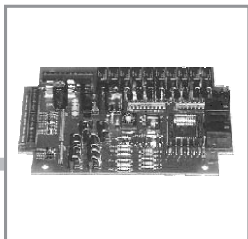

DC-5 Control

24

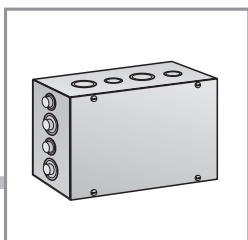
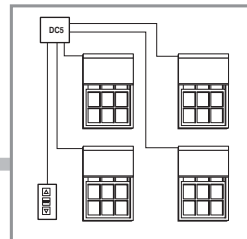

Group Control System II (GCS II)

26

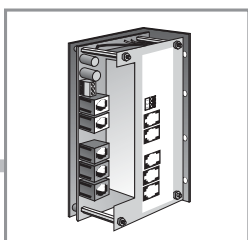
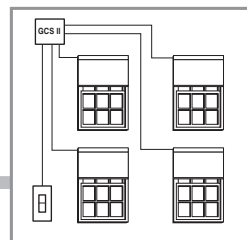

Individual-Group Control (IGC and IGC/3N1)

28

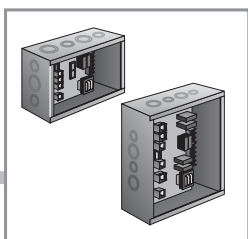

Individual-Group Control II (IGC II and IGC II/3N1)

31

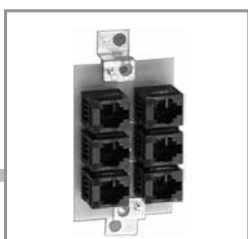

Subgroup Controller

34

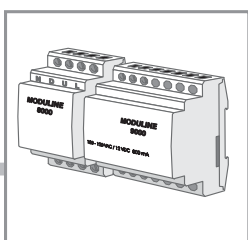

Moduline System

35

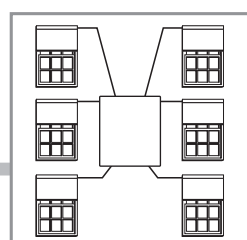

INDIVIDUAL GROUP CONTROL SYSTEM FOR DC MOTORS (IGC-DC)

DESCRIPTION

The IGC-DC provides control of one or more DC motors in groups and/or individually from one or more locations. It provides both lift and tilt capabilities for horizontal blind applications. The IGC-DC is a very flexible control system that can be configured in a variety of ways (i.e.; individual window control, floor control, total building control, etc.) to meet the requirements of your customers. Unlike the IGC, the IGC-DC is a switch and motor controller all in one package, and can be installed in a single gang electrical box.



MECHANICAL SPECIFICATIONS:

Overall Dimensions: L: 4 1/2 in. W: 2 3/4 in. D: 1 1/8 in.

Installs in a standard single gang electrical box.

ELECTRICAL SPECIFICATIONS

Voltage Rating: INPUT: 12 or 24 VDC

OUTPUT: 12 or 24 VDC 750mA per motor

Approvals: Complies with the National Electrical Code (NEC) Standard

RECOMMENDED TRANSFORMERS

MOTOR TYPE	1 MOTOR	2 MOTOR	3 MOTOR	4 MOTOR	5 MOTOR
LT28A	5700091	5700091	5700091	5700091	5700092
LT28B	5700095	5700093	5700093	5700096	5700096
LV25-B44	5700095	5700093	5700096	5700096	5700096
LV25-B64	5700095	5700093	5700096	5700096	5700096
LW25-B83	5700095	5700093	5700096	5700096	5700098
LT28-H2	5700093	5700098	5700098	5700098	5700098

CONNECTION DIAGRAM

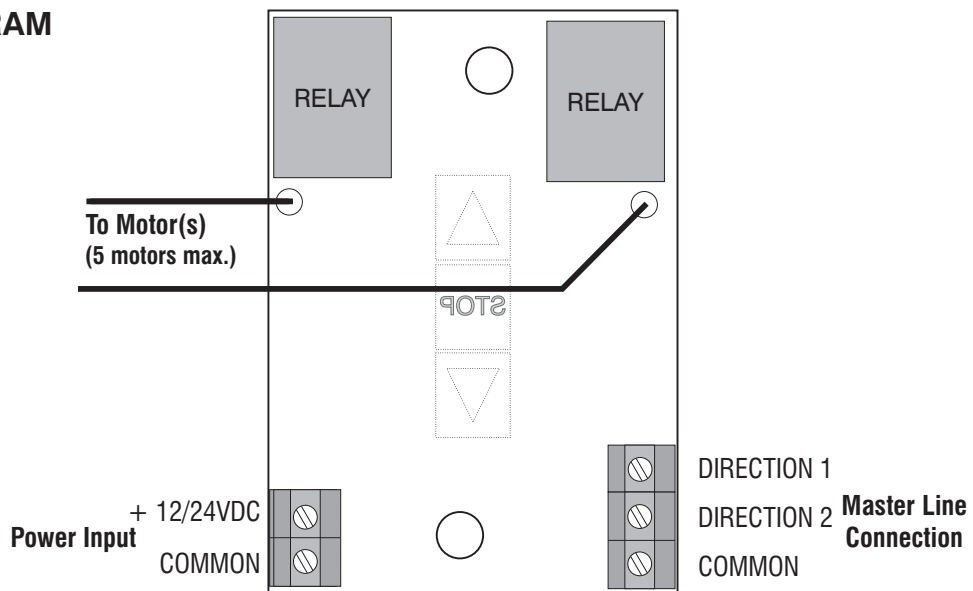

MOTOR CONTROL EXAMPLES

3 DC Motors Individually Controlled

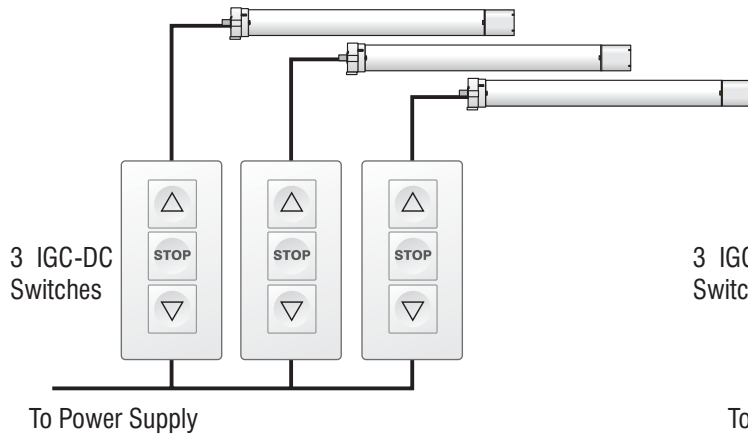

3 DC Motors Controlled Individually & as a Group

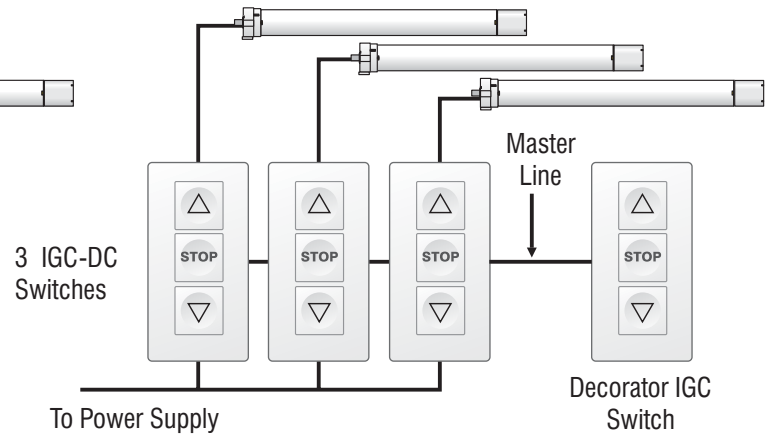

15 DC Motors Controlled as a Group & in Sub-Groups

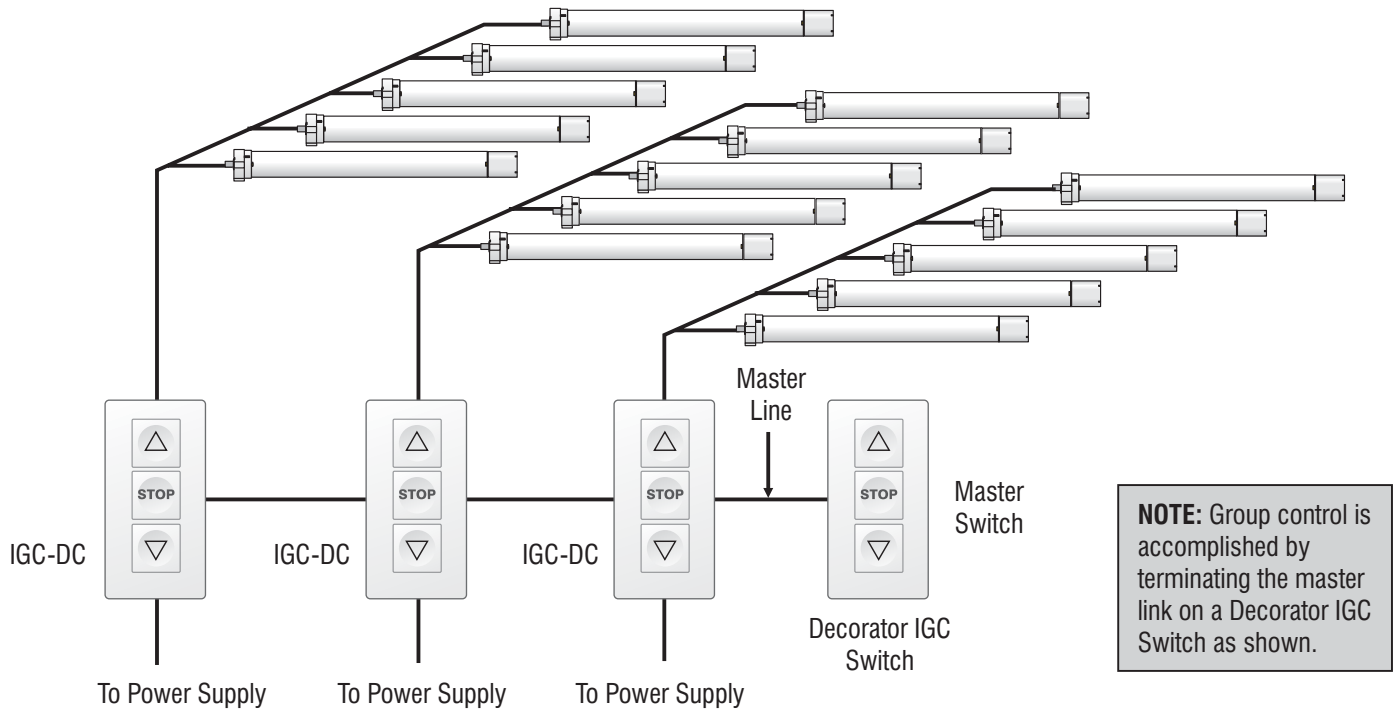

ORDERING INFORMATION

Description

Catalog Number

Switches

IGC-DC (White)

6300843

IGC-DC (Ivory)

6300840

Group Switches

Single IGC Switch (White)

6300040

Dual IGC Switch (White)

6300041

Single IGC Switch (Ivory)

6300140

Dual IGC Switch (Ivory)

6300141

Description

Catalog Number

Transformers

12 VDC, 1A

5700088

12 VDC, 3A

5700091

12 VDC, 5A

5700092

24 VDC, 600mA

5700095

24 VDC, 1A

5700093

24 VDC, 2.5A

5700096

24 VDC, 6.5A

5700098

DC5 CONTROL

DESCRIPTION

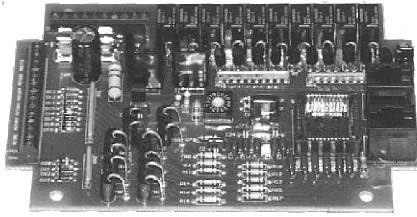

The SOMFY DC-5 is a 5-motor individual and group control system for 12 and 24 volt DC motors. It can be controlled by IGC switches or infrared control. There are many different switch combinations to allow for individual, group or sub-group control. The DC-5 also has tilting capabilities for horizontal blind applications.

MECHANICAL SPECIFICATIONS

Overall Dimensions: L: 6 in. W: 4 1/4 in. D: 2 1/4 in.

ELECTRICAL SPECIFICATIONS

Voltage Rating: INPUT: 12 or 24 VDC

OUTPUT: 12 or 24 VDC 750mA per motor

Approvals: Complies with the National Electrical Code (NEC) Standard

RECOMMENDED TRANSFORMERS

MOTOR TYPE	1 MOTOR	2 MOTOR	3 MOTOR	4 MOTOR	5 MOTOR
LT28A	5700088	5700091	5700091	5700091	5700092
LT28B	5700095	5700093	5700193	5700096	5700096
LV25-B44	5700095	5700093	5700096	5700096	5700096
LV25-B64	5700095	5700093	5700096	5700096	5700096
LW25-B83	5700095	5700193	5700096	5700096	5700098
LT28-H2	5700093	5700098	5700098	5700098	5700098

ORDERING INFORMATION

Description	Catalog Number	Description	Catalog Number
DC-5 Control	6300370	Transformers	
Switches		12 VDC, 1A	5700088
Single IGC Switch	6300040 (White), 6300140 (Ivory)	12 VDC, 3A	5700091
Dual IGC Switch	6300041 (White), 6300141 (Ivory)	12 VDC, 5A	5700092
Infrared Switch	6300050 (White), 6300060 (Ivory)	24 VDC, 600mA	5700095
IntelliS - IGC	6300351 (White), 6300352 (Ivory)	24 VDC, 1A	5700093
Accessories		24 VDC, 2.5A	5700096
Infrared Sensor	6300866	24 VDC, 6.5A	5700098
Single Channel IR Transmitter	6300879		
Eight Channel IR Transmitter	6300988		
Plastic Enclosure	6111370		

WIRING DIAGRAM

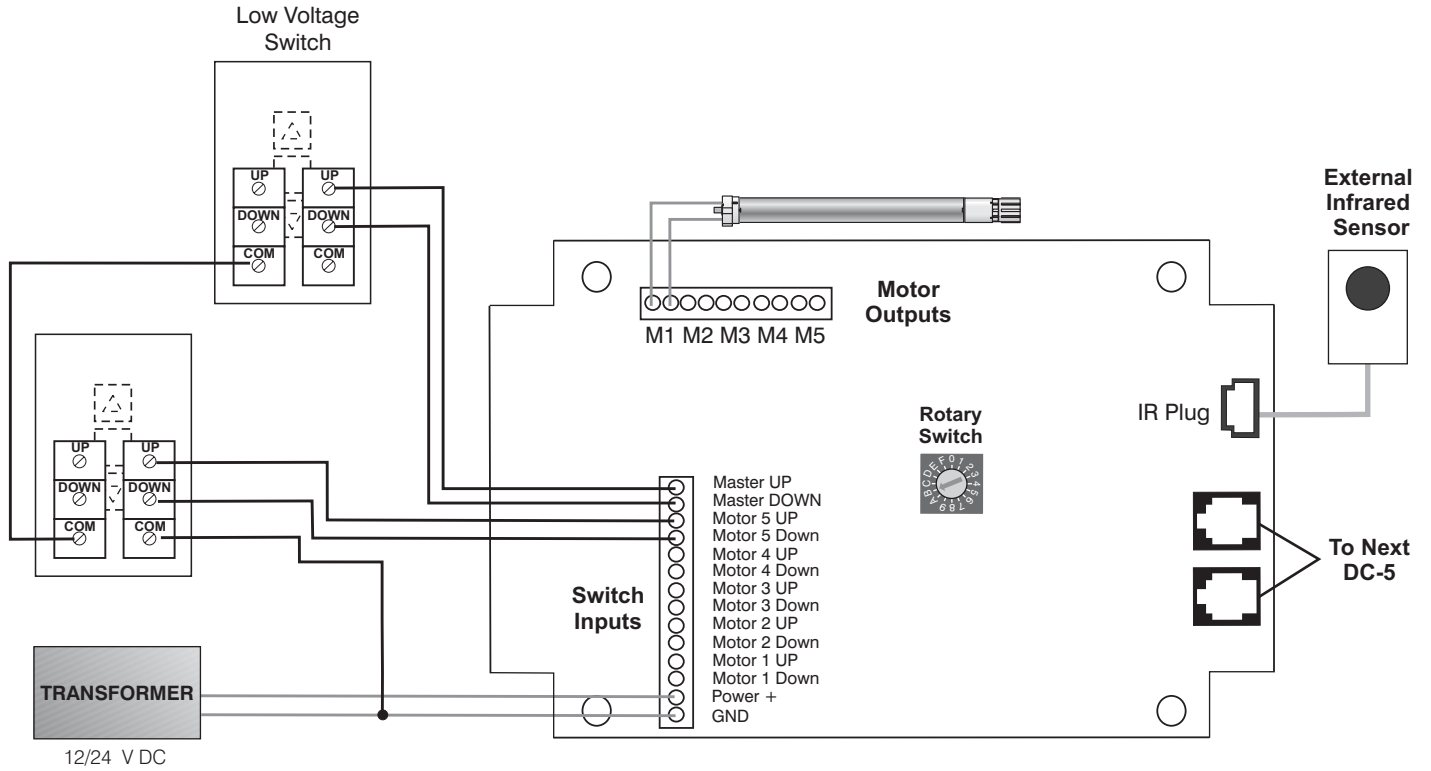

HOME AUTOMATION INTERFACE

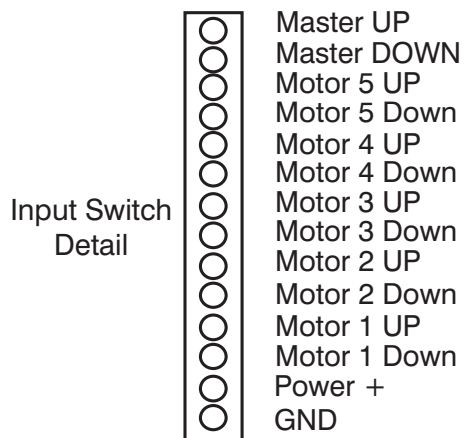

The screw terminals on the DC5 can be used for interfacing to home automation or other third party systems. To activate a Master Up command, a momentary dry contact (relay) closure is required between the MASTER UP input and GND. This contact should remain closed for less than 0.5 seconds to raise or lower a shade, or more than 0.5 seconds to tilt a horizontal blind.. Similarly, to activate a Master Down command, a contact closure is required between the MASTER DOWN and GND terminals. To activate a STOP command, a contact closure is required between the MASTER UP, MASTER DOWN and GND terminals.

Follow the above timing requirements for each of the individual inputs, Motor1 through Motor5.

GROUP CONTROL SYSTEM II

(GCS-II)

DESCRIPTION

The Group Control System-II (GCS-II) permits low voltage control of up to four SOMFY operators with one or more switches, from one or more locations. Optional low voltage control can be accomplished using SOMFY's Decorator Somfy-Matic™, Decorator Comfort Control or Radio Remote Control Kit. The GCS-II offers only group control, and does not have the capability of operating each motor individually. The Group Control System-II is UL and cUL approved.

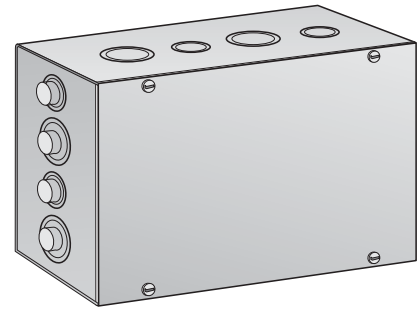

For applications requiring more than 4 motors operated by the same switch, the GCS-II can be daisy-chained by way of the low voltage switch terminals.

MECHANICAL SPECIFICATIONS

Overall Dimensions: L: 8 in. W: 10 in. D: 4 in.

ELECTRICAL SPECIFICATIONS

Voltage Ratings:

INPUT: Line Voltage: 115 VAC +/- 10% 50/60 Hz 20A

Low Voltage: 12 VDC 0.3A

OUTPUT: 115 VAC 5A (Each motor)

Fuses: (Motor) 2 x 10A (One per two motors)
(Low Voltage) 1/2A

Approvals:

Conforms to UL508 standard for industrial controls

Complies with the National Electrical Code Standards (NEC)

HOME AUTOMATION INTERFACE

MODULAR CONNECTOR



SENSORS CONNECTION

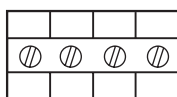

12	W	S
V	I	U
D	N	N
C	D	

LOW VOLTAGE SWITCH CONNECTION

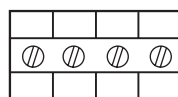

U	D	C
P	O	O
	W	M
	N	M
		O
		N

Low voltage terminals are provided on the GCS-II for interfacing to home automation or other third party systems. To activate an Up command, a maintained dry contact (relay) closure is required between the UP input and COMMON. This contact should remain closed for approximately 3 minutes to ensure full travel of the window treatment. Similarly, to activate a Down command, a contact closure is required between the DOWN and COMMON terminals. The window treatment will stop when the contact closure is released.

TYPICAL APPLICATION

Single GCS

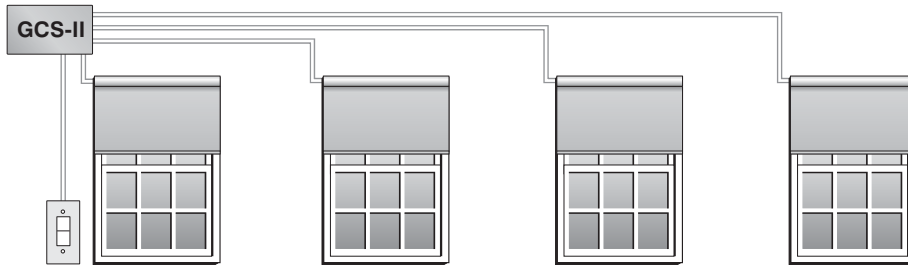

A single GCS controls up to four motors with one switch. GCS's work in tandem by linking the switch terminals.

Two or more GCS's



GCS-II WIRING DIAGRAM

CAUTION: Before proceeding with the line voltage wiring instructions, the up and down limits of each motor should be set using the SOMFY tester cable (Cat. No. 6020086). Refer to the limit switch instructions packaged with each SOMFY motor for more information.

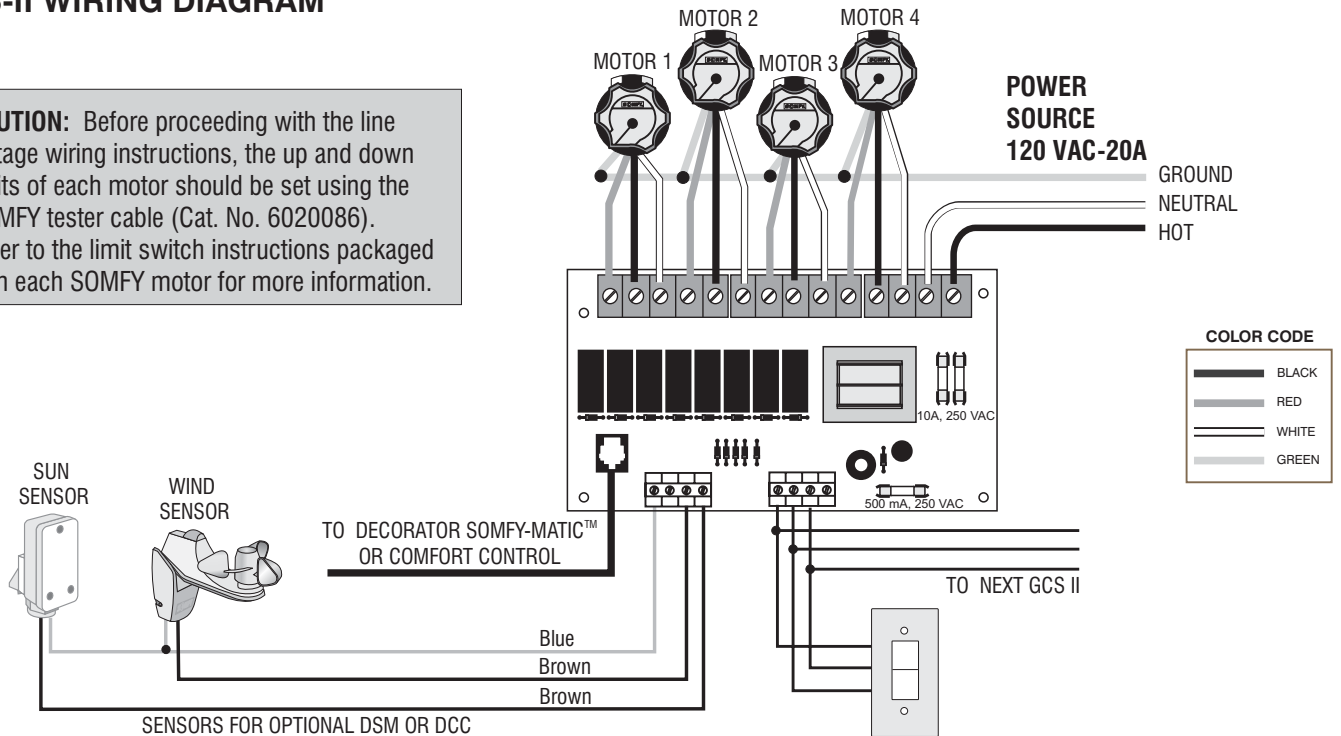

ORDERING INFORMATION

Description	Catalog Number	Description	Catalog Number
GCS-II 115 VAC	6300123	Maintained Paddle Switch (Ivory)	6120726
GCS-II 220 VAC	6300124	Maintained Paddle Switch (White)	6120727
Infrared Switch	6300051 (White), 6300061 (Ivory)	Momentary Paddle Switch (Ivory)	6120734
IntelliS Timer	6300361 (White), 6300362 (Ivory)	Momentary Paddle Switch (White)	6120735
Remote Control Kit	6300696	Maintained Toggle Switch (Ivory)	6120745
Maintained Rocker Switch	6120144	Maintained Toggle Switch (White)	6120746
Momentary Rocker Switch	6120155	Momentary Toggle Switch (Ivory)	6120747
		Momentary Toggle Switch (White)	6120748

INDIVIDUAL-GROUP CONTROL

(IGC and IGC/3N1)

DESCRIPTION

The IGC series provides control of one or more motors in groups and/or individually from one or more locations. This advanced yet simple to install modular control system can be activated manually or automatically. The heart of the system is the IGC Motor Controller used for each motor. However, greater economy can be obtained using the IGC/3N1 version for those jobs that call for controlling at least three motors individually or in groups.

The IGC is a very flexible control system that can be configured in a variety of ways (individual window control, floor control, total building control, etc.) to meet the requirements of your customers.

The Individual IGC Controller has an added feature. It is equipped with a dry contact input that can interface with a window alarm system. One typical application is for casement windows; when the window is open, the motor will not operate. This will help prevent damage to window coverings.

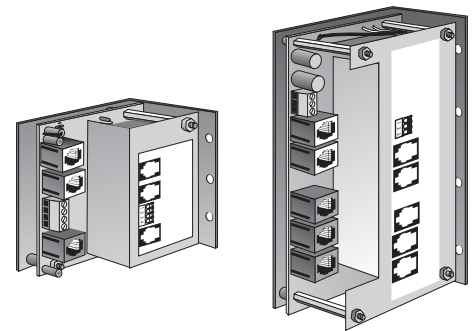

MECHANICAL SPECIFICATIONS

Overall Dimensions: IGC: L: 3 1/2 in. W: 3 3/8 in. D: 2 1/4 in.

IGC/3N1: L: 7 3/16 in. W: 3 1/2 in. D: 1 7/8 in.

IGC fits in a 2 gang masonry electrical box. IGC/3N1 fits in a 4 gang masonry electrical box

ELECTRICAL SPECIFICATIONS

Voltage Ratings:

IGC:	INPUT:	Line Voltage:	115 VAC +/- 10% 50/60 Hz		
		Low Voltage:	12 VDC 90mA maximum consumption		
	OUTPUT:	115 VAC	5A	1/4 HP	
		Fuse	5A		
IGC/3N1:	INPUT:	Line Voltage:	115 VAC +/- 10% 50/60 Hz		
		Low Voltage:	12 VDC 185mA maximum consumption		
	OUTPUT:	115 VAC	15A (5A per motor)	1/4 HP	
		Fuse:	3 x 5A		

Approvals:

Both the IGC and IGC/3N1 conform to UL508 for industrial controls.
Complies with the National Electrical Code Standards (NEC)
UL and cUL approved

APPLICATION NOTES

The Individual-Group Control System is compatible with other SOMFY Controls (i.e., Remote Control, Intellis Timer, Decorator Somfy-Matic™, Decorator Comfort Control, etc.) and other security, lighting and HVAC systems.

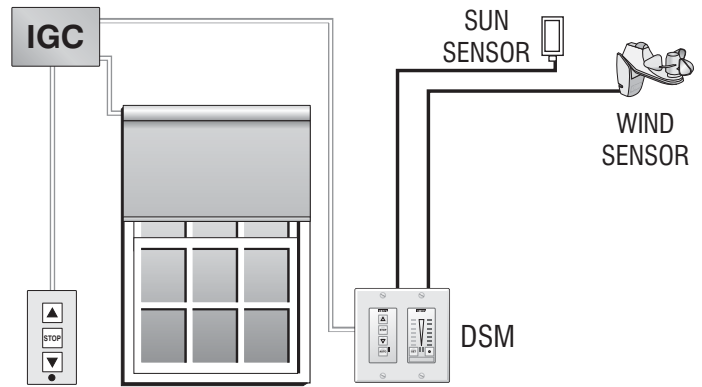

IGC WIRING SCHEMATIC

M = MASTER
IND = INDIVIDUAL

CAUTION: Before proceeding with the line voltage wiring instructions, the up and down limits of each motor should be set using the SOMFY tester cable (Cat. No. 6020086). Refer to the limit switch instructions packaged with each SOMFY motor for more information.

COLOR CODE

	BLACK
	BROWN
	RED
	WHITE
	GREEN

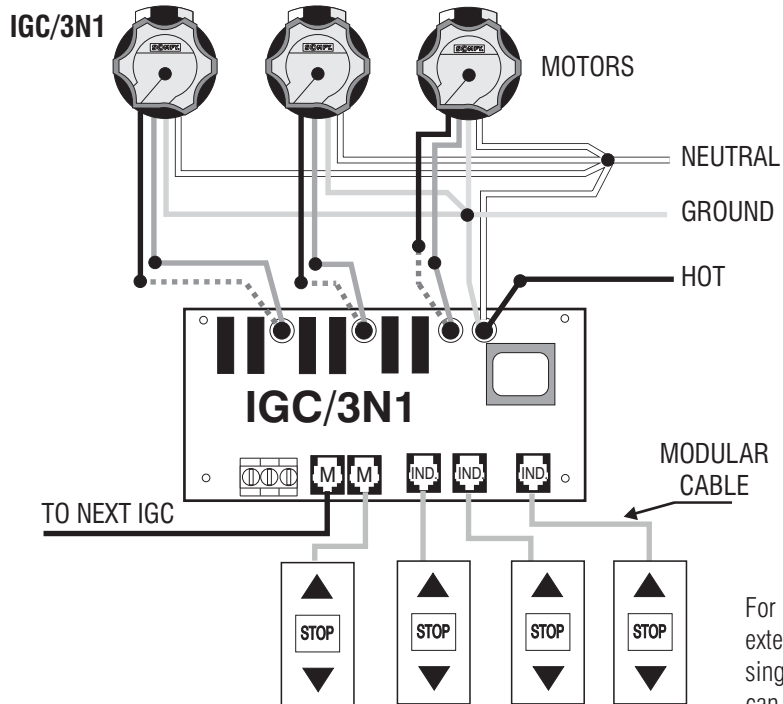

LOW VOLTAGE TERMINALS DETAIL

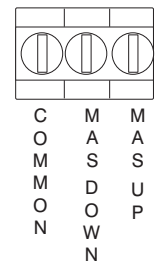

For group only control from an external device, a single-pole, single-throw momentary switch can be connected between either the MAS (Master) UP and COMMON or MAS DOWN and COMMON terminals.

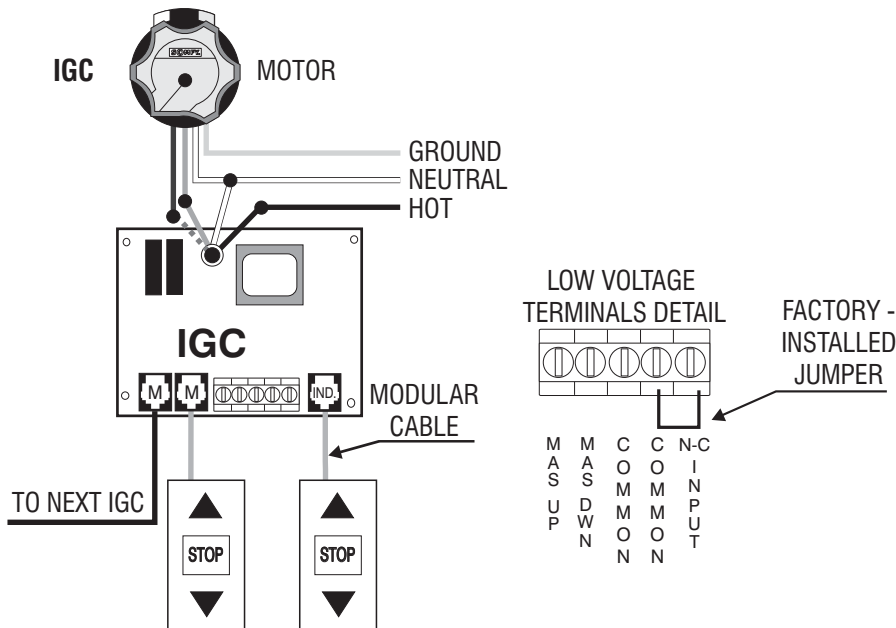

LOW VOLTAGE TERMINALS DETAIL

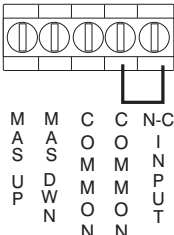

FACTORY -
INSTALLED
JUMPER

For group only control from an external device, a single-pole, single-throw momentary switch can be connected between either the MAS UP and COMMON or MAS DOWN and COMMON terminals.

The N-C (normally closed) INPUT terminal is for a normally closed contact connected to a casement window or french door. When the door or window opens, this contact opens and disables the down direction. **DO NOT REMOVE FACTORY INSTALLED JUMPER IF THIS FEATURE IS NOT UTILIZED.**

HOME AUTOMATION INTERFACE

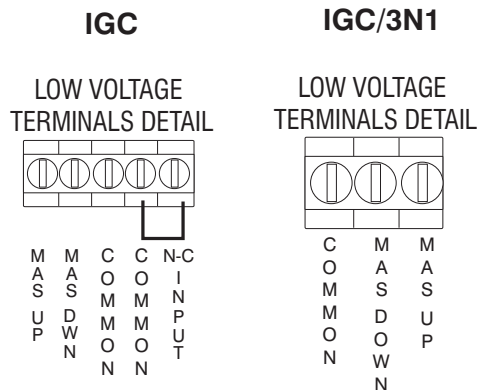

Low voltage terminals are provided on both the single motor IGC and IGC/3N1 for interfacing to home automation or other third party systems. To activate a Master Up command, a momentary dry contact (relay) closure is required between the MAS UP input and COMMON. This contact should remain closed at least 0.5 seconds, but no more than 1 second. Similarly, to activate a Master Down command, a contact closure is required between the MAS DWN and COMMON terminals.

If the window treatment is in motion, a Stop command is given by activating the direction of movement. For example, if the treatment is moving up, activating another UP command within 3 minutes will stop the window treatment. Alternately, to activate a STOP command, a contact closure is required between the MAS UP, MAS DWN and COMMON terminals.

IGC - HB FOR HORIZONTAL BLINDS

The IGC-HB and IGC-HB/3N1 are specifically designed to provide lift and tilt capability for horizontal blind applications. They are completely compatible with SOMFY's standard IGC, so wiring and basic operation are similar. When using the IGC-HB in combination with a decorator IGC switch, a blind can be raised or lowered by momentarily pressing and releasing the UP or DOWN button. The TILT function is activated by pressing and holding the button corresponding to the desired direction of tilt. When the slats are at the desired angle, simply release the directional button.

For Home Automation interfacing, a contact closure is required as with the standard IGC. The contact should remain closed for less than 0.5 seconds for raising or lowering blinds and greater than 0.5 seconds for tilting. The Stop function can only be activated with a simultaneous contact closure between the MAS UP, MAS DWN and COMMON terminals.

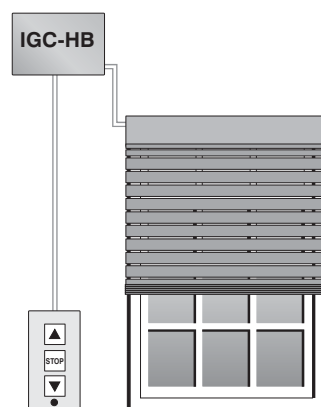

ORDERING INFORMATION

Description

IGC - 115 VAC
IGC - HB
IGC - 220 VAC
IGC - Dry Contact Capability
IGC/3N1 - 115 VAC
IGC-HB/3N1
IGC/3N1 - 220 VAC

Catalog Number

6300717
6300030
6300845
6300713
6300719
6300035
6300846

Switches

Single IGC Switch
Dual IGC Switch
Infrared Switch

6300908 (White) 6300937 (Ivory)
6300909 (White) 6300938 (Ivory)
6300050 (White) 6300060 (Ivory)

Options

IGC Sub Group
Radio Remote Control Kit
IntelliS Timer
Outdoor Digital Keypad
2 Gang Masonry Electrical Box
4 Gang Masonry Electrical Box

6300715
6300448
6300351 (White) 6300352 (Ivory)
6300849
5670323
5670064



Single IGC Switch



Dual IGC Switch

NOTE: See accessories section for modular cable and connectors

INDIVIDUAL-GROUP CONTROL II

(IGC II and IGC II/3N1 - X10 COMPATIBLE)

DESCRIPTION

The IGC-II system provides control of one or more motors in groups and/or individually from one or more locations. This advanced, yet simple-to-install modular control system can be activated manually or automatically. The heart of the system is the IGC-II Motor Controller used for each motor. However, greater economy can be obtained using the IGC-II/3N1 for those jobs that call for controlling three motors individually or in groups. The IGC-II is a very flexible control system that can be configured in a variety of ways (i.e., individual window control, floor control, total building control, etc.) to meet the requirements of your customers.

The IGC-II and IGC-II/3N1 controllers are also compatible with X10 power

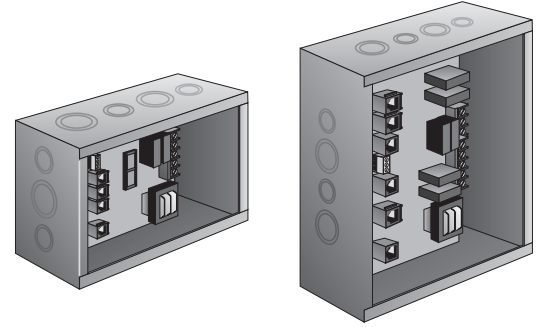

line transmission technology. When the IGC-II is used with the SOMFY X10 system, it is possible (without additional wiring) to control motorized coverings as well as other X10 compatible devices.

MECHANICAL SPECIFICATIONS

Overall Dimensions: IGC-II: L: 6 in. W: 8 in. D: 4 in.
IGC-II/3N1: L: 6 in. W: 10 in. D: 4 in.

ELECTRICAL SPECIFICATIONS

Voltage Ratings:

IGC-II:	INPUT:			
	Line Voltage:	115 VAC	+/- 10%	50/60 Hz
	Low Voltage:	12 VDC	90mA maximum consumption	
	OUTPUT:	115 VAC	5A	1/4HP
		Fuse	5A	
IGC-II/3N1	INPUT:			
	Line Voltage:	115 VAC	+/- 10%	50/60 Hz
	Low Voltage:	12 VDC	185mA maximum consumption	
	OUTPUT:	115 VAC	15A (5A per motor)	
		Fuse	15A	

Approvals:

Both the IGC-II and IGC-II/3N1 conform to UL508 standard for industrial controls. Complies with the National Electrical Code Standards (NEC).

WIRING SCHEMATIC

IGC-II/3N1

M = MASTER
IND = INDIVIDUAL

CAUTION: Before proceeding with the line voltage wiring instructions, the up and down limits of each motor should be set using the SOMFY tester cable (Cat. No. 6020086). Refer to the limit switch instructions packaged with each SOMFY motor for more information.

COLOR CODE

	BLACK
	RED
	WHITE
	GREEN

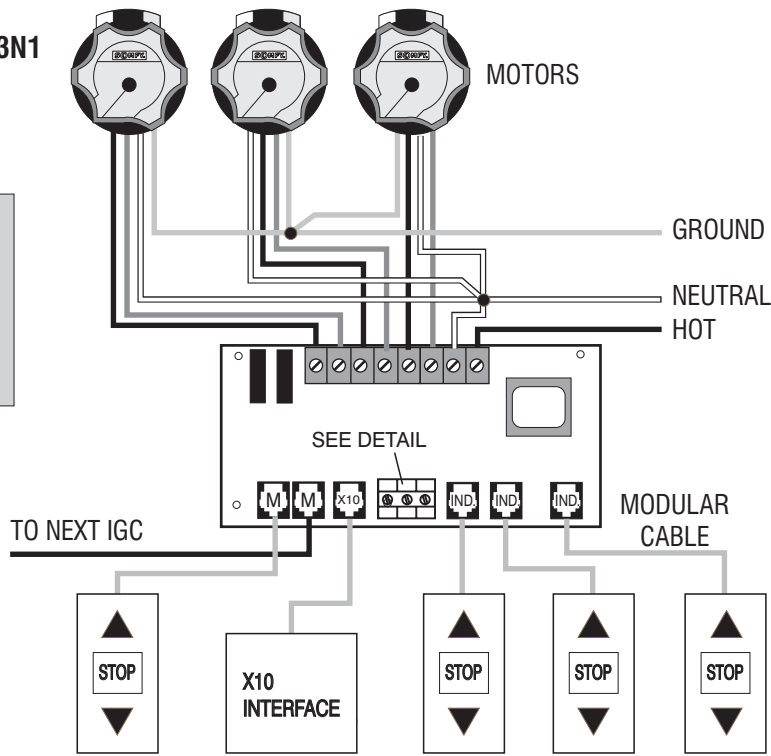

LOW VOLTAGE TERMINALS DETAIL

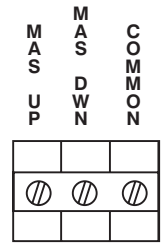

For group only control from an external device, a single-pole, single-throw momentary switch can be connected between either the MAS UP and COMMON or MAS DWN and COMMON terminals.

IGC-II

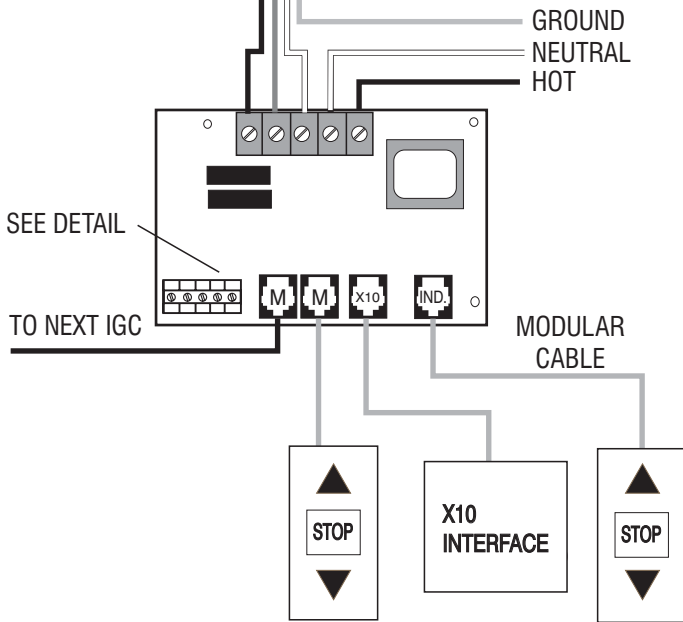

LOW VOLTAGE TERMINALS DETAIL

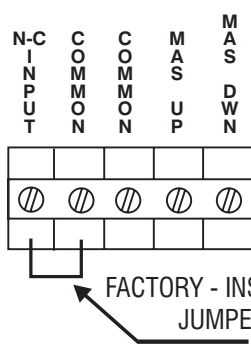

For group only control, a single-pole, single-throw momentary switch can be connected between either the MAS (Master) UP and COMMON or MAS DOWN and COMMON terminals.

The N-C (normally closed) INPUT terminal is for a normally closed contact connected to a casement window or french door. When the door or window opens, this contact opens and disables the down direction. **DO NOT REMOVE FACTORY INSTALLED JUMPER** IF THIS FEATURE IS NOT UTILIZED.

APPLICATION NOTES

The Individual-Group Control System II is compatible with other SOMFY Controls (i.e., Remote Control, Intellis Timer, Decorator Somfy-Matic™, Decorator Comfort Control, etc.) and other security, lighting and HVAC systems. The individual IGC-II Controller has an added feature. It is equipped with a dry contact input that can interface with a window alarm system. One typical application is for casement windows; when the window is open, the motor will not operate. This is to help prevent damage to window coverings.

IGC-II/3N1 Three Motor Control with Individual and Master Control

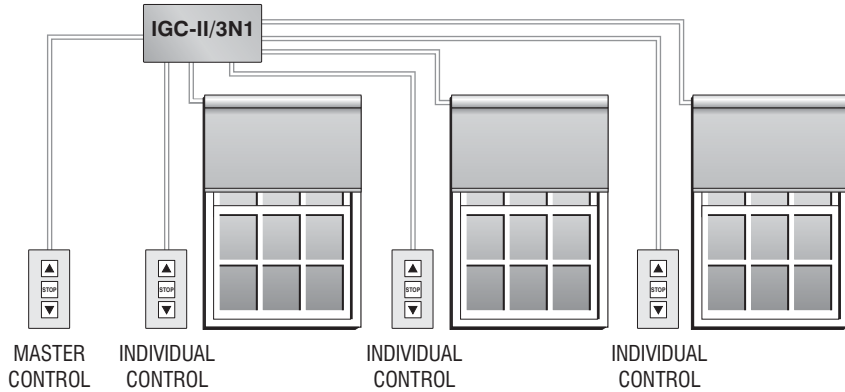

IGC-II Single Motor Control with Command Center

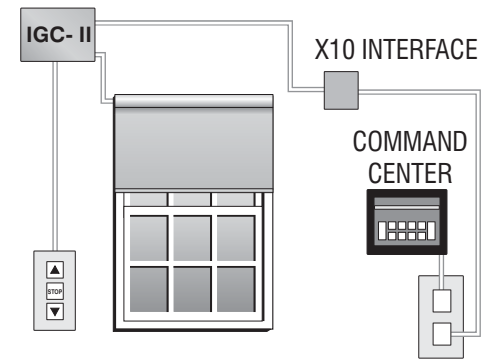

HOME AUTOMATION INTERFACE

IGC-II

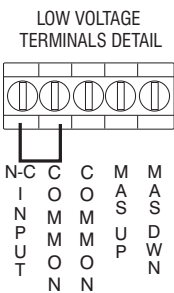

IGC-II/3N1

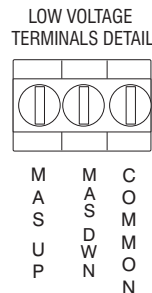

Low voltage terminals are provided on both the single motor IGC-II and IGC-II/3N1 for interfacing to home automation or other third party systems. To activate a Master Up command, a momentary dry contact (relay) closure is required between the MAS UP input and COMMON. This contact should remain closed at least 0.5 seconds, but no more than 1 second. Similarly, to activate a Master Down command, a contact closure is required between the MAS DWN and COMMON terminals. To activate a STOP command, a contact closure is required between the MAS UP, MAS DWN and COMMON terminals.

ORDERING INFORMATION

Description	Catalog Number	Description	Catalog Number
IGC-II	6300817	Switches	
IGC-II/3N1	6300819	Single IGC Switch	6300908 (White) 6300937 (Ivory)
		Dual IGC Switch	6300909 (White) 6300938 (Ivory)
		Infrared Switch	6300050 (White) 6300060 (Ivory)
X10 Components		Options	
IRC Command Center	6150463	IGC Sub Group	6150715
X10 Interface	6300821	Radio Remote Control Kit	6300448
IRC1000 Transmitter	6150460	Outdoor Digital Keypad	6300849
		IntelliS Timer	6300351 (White) 6300352 (Ivory)

IGC SUB-GROUP CONTROL

DESCRIPTION

The SubGroup controller is designed for use with Somfy's IGC or IGC-II controls. It allows for master or group control of a number of IGC controls from a single switch while still maintaining independent operation of each control or group.

- MOUNTS IN SINGLE GANG BOX
- SUB-GROUPS OPERATE INDEPENDENTLY
- MASTER LINE ACTIVATES ALL SUB-GROUPS
- ONLY ONE LEVEL OF SUB-GROUPING IS POSSIBLE. DO NOT CONNECT A SUB-GROUP PORT OF ONE SUB-GROUP CONTROL TO A MASTER PORT OF ANOTHER SUB-GROUP CONTROL. IF MULTI-LEVEL SUB-GROUPING IS NEEDED, IT MUST BE DONE AT THE IGC CONTROLS.

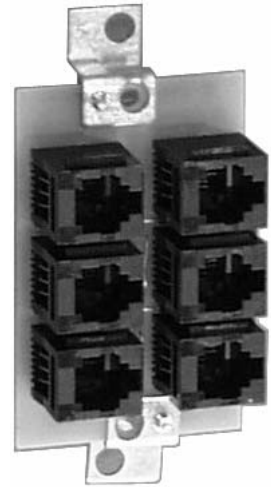

Cat. No. 6300715

TYPICAL APPLICATION

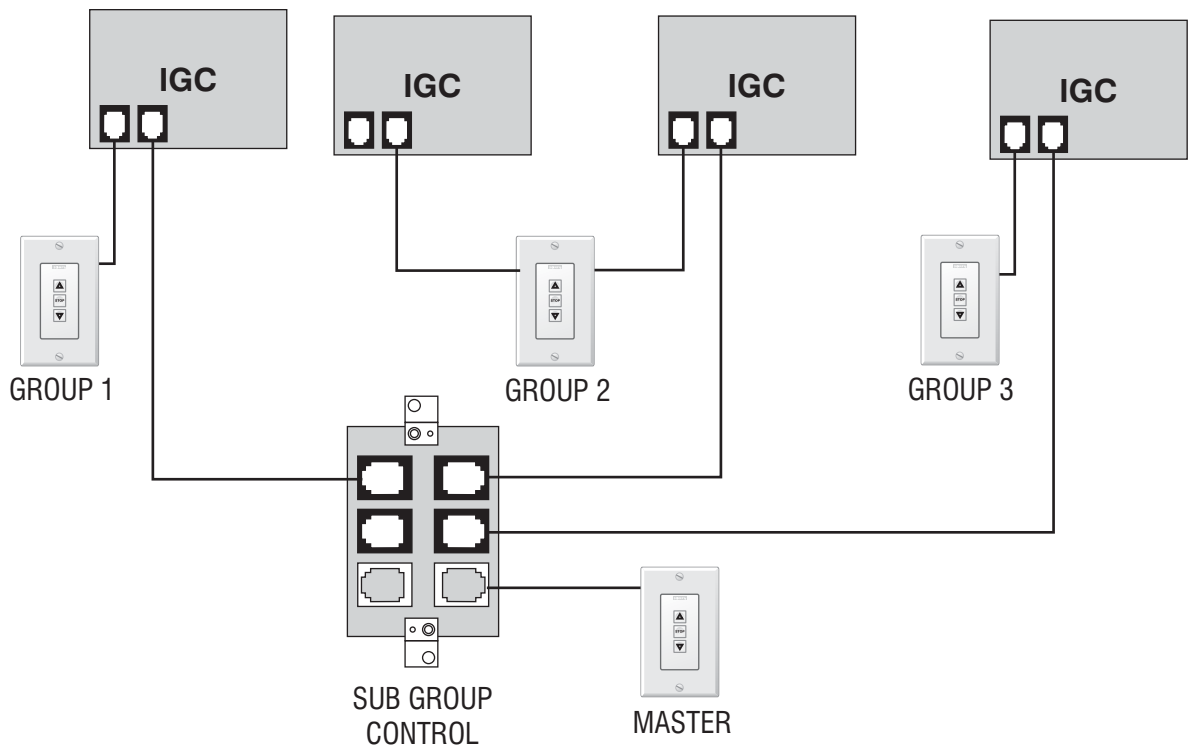

MODULINE SYSTEM

DESCRIPTION

The Moduline system features individual and group controls built into standard DIN casings which are attached to DIN rails in a cabinet. The system includes modules for individual, group and master control. A preassembled control system of Moduline components can be built to meet your specifications. The Moduline system requires minimal wiring and reduced troubleshooting and maintenance times. It offers an integrated and organized means for controlling SOMFY motors.

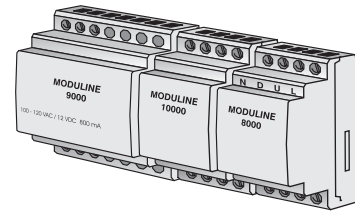

SYSTEM COMPONENTS

Supply/General Control MODULINE 9000

The Moduline 9000 supplies power and master control for up to 15 individual controls that are connected to its right.

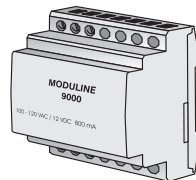

Sub Group Control MODULINE 10000

The Moduline 10000 allows group operation of a number of Individual controls from a single switch. This module will control any Moduline connected on its right side.

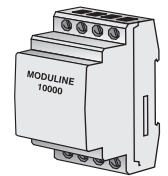

Individual Control MODULINE 8000

This device provides individual control of a window treatment. It communicates with other modules, such as the 9000, that are connected in line with it.

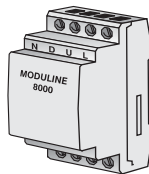

Sun and Wind Interface MODULINE 1010

This module interfaces with a Sun and Wind Sensor to provide shading from the sun and protection from the wind automatically.

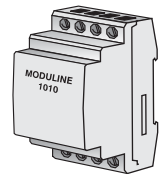

Individual Control for Horizontal Blinds MODULINE 8100

This module provides individual control of a horizontal blind. It is specifically designed to provide both lift and tilt capabilities.

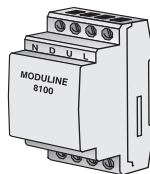

SPECIFICATIONS

MODULINE 9000

Electrical Specifications: INPUT: 120 VAC 50/60 Hz OUTPUT: 12VDC, 0.5A (to bus line)
Mechanical Specifications: L: 2 ⁴/₅ in. W: 3 ²/₅ in. D: 2 ¹/₂ in.

MODULINE 8000 & 8100

Electrical Specifications: INPUT: 12 VDC (from Moduline 9000); OUTPUT: 120 VAC 5A
Mechanical Specifications: L: 1 ²/₅ in. W: 3 ²/₅ in. D: 2 ¹/₂ in.

MODULINE 10000

Electrical Specifications: INPUT: 12 VDC (from Moduline 9000)
Mechanical Specifications: L: 1 ²/₅ in. W: 3 ²/₅ in. H: 2 ¹/₂ in.

MODULINE 1010

Mechanical Specifications: L: 1 ²/₅ in. W: 3 ²/₅ in. H: 2 ¹/₂ in.

TYPICAL MODULINE WIRING DIAGRAM

CAUTION: Before continuing with the line voltage wiring instructions, the up and down limits of each motor should be set using the SOMFY tester cable (Cat. No. 6020086). Refer to limit switch instructions packaged with each SOMFY motor for more information.

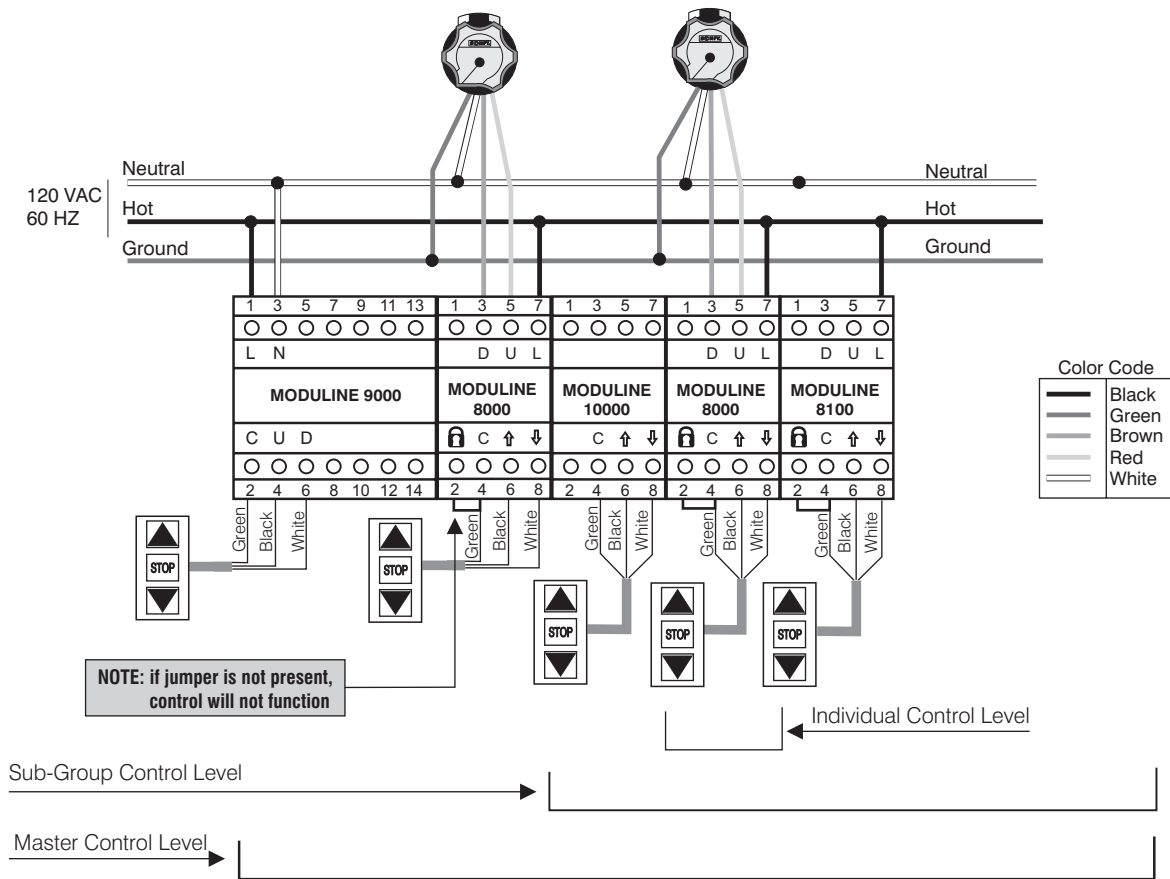

OPERATING PROCEDURES

A. Individual Motor Operation

A single motor can be controlled by a Moduline 8000 from its corresponding switch. To activate either direction, momentarily depress the button corresponding to the desired direction. A single motor can be stopped in any position by depressing the stop button.

B. Subgroup Operation

A group of motors can be controlled by connecting Moduline 8000s to the right of a Moduline 10000. When the switch connected to the Moduline 10000 is depressed, all Moduline 8000s in the subgroup (up to the next Moduline 10000) will be activated.

C. Master Control

All the motors (Up to 15 Moduline 8000s) in a system can be controlled and operated by a single switch connected to a Moduline 9000. To activate any direction, momentarily depress the corresponding button. The motors can be stopped in any position by depressing the stop button.

ORDERING INFORMATION

Description	Catalog Number	Description	Catalog Number
Moduline 8000	6150472	Single IGC Switch	6300040 (White), 6300140 (Ivory)
Moduline 8100	6150476	Dual IGC Switch	6300041 (White), 6300141 (Ivory)
Moduline 9000	6150474	Linking Module	6150473
Moduline 10000	6150471		
Moduline 1010	6150478		

NOTE: Moduline components can be assembled as a UL listed system by SOMFY. Please consult your sales representative for details.

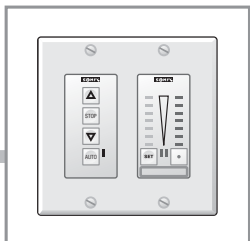

Decorator Somfy-Matic™ (DSM)

38

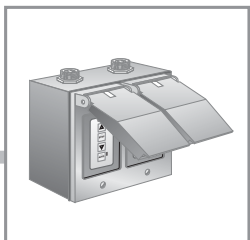
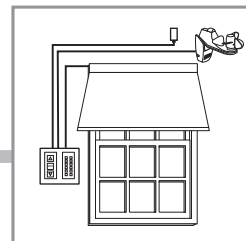

*Decorator Somfy-Matic™
Outdoor Plug-in System*

40

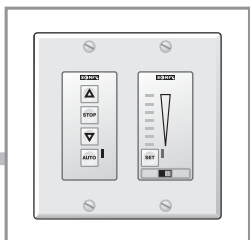
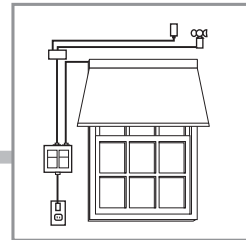

Decorator Comfort Control (DCC)

42

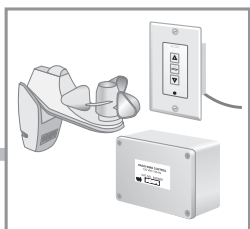
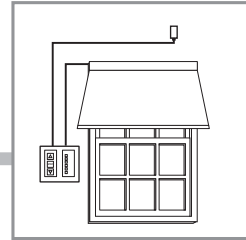

Wind-A-Matic II

44

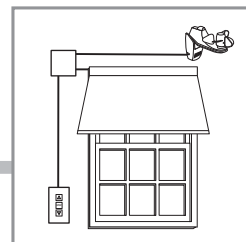

Eolis Receiver

46

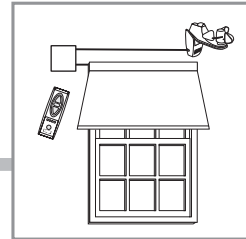

*Soliris Receiver
Telis Soliris Transmitter*

48
50

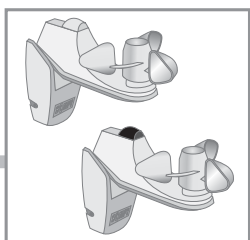
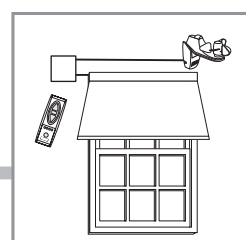

RTS Sensors

51

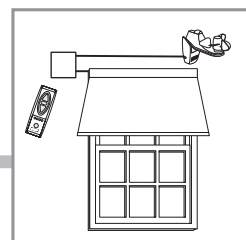

DECORATOR SOMFY-MATIC™ (DSM)

DESCRIPTION

The Decorator Somfy-Matic™ (DSM) enables a retractable awning to provide shading from the sun and protection from the wind automatically and conveniently. The DSM sun and wind sensors continually monitor sun intensity and wind speed, triggering the control unit to extend or retract the awning as needed.

The Decorator Somfy-Matic™ features advanced circuitry that assures factory preset accuracy and proven reliability. It aids in protecting furniture and carpeting from fading and saves on heating and air conditioning costs. With its sleek design, the DSM will complement any home decor. Combine this with the capability of being linked to SOMFY'S Group Control and IGC systems, and you've got the most flexible product on the market today!

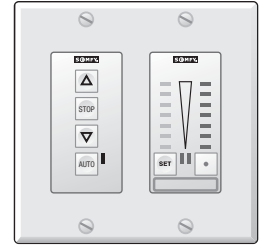

MECHANICAL SPECIFICATIONS

Overall Dimensions: L: 3 1/2 in. W: 2 3/4 in. D: 1 1/3 in.
Operating temperature range: -20 °C to 50 °C (-5 °F to 120 °F)
Wind Speed: From 12 to 31 mph
Fits in most 2 gang electrical boxes

ELECTRICAL SPECIFICATIONS

Voltage Rating:
Single Motor: INPUT: 115 VAC +/- 10% 50/60Hz
OUTPUT: 115 VAC 1/4 HP 5A

IGC/GCS II: INPUT: 12-15 VDC 150 mA (Supplied by IGC or GCS II)
OUTPUT: 12-15 VDC 100 mA Open Collector

Approvals:
The DSM Single Motor Control is approved per UL508 for industrial controls (UL, cUL);
Conforms to the National Electrical Code Standards (NEC)

INSTALLATION PROCEDURES

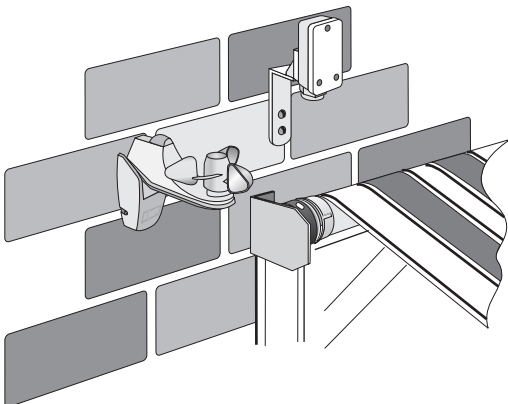

1. Make sure that the sun sensor is mounted outside, facing the sun and is not shaded by trees or other building structures. It should be mounted as high as possible, no more than 100 feet from the Decorator Somfy-Matic™. The detection angle is up to 100 degrees wide from the center of the sensor face. Connect the sensor wires to the terminal block as shown in the wiring diagram on the next page.
2. The wind sensor should be placed close to the awning or shading system to make sure the wind speed is measured at the product. Guard against installing the wind sensor too close to an obstruction such as a chimney, gutter or the awning itself, which may block the wind and cause erroneous readings. The wind sensor should not be more than 100 feet from the DSM. Connect the wind sensor wires to the terminal block as shown on the next page.
3. For the Single Motor model, connect the motor wires to the DSM as illustrated. For the IGC/GCS II models, using appropriate length modular cable, connect from the IGC/GCS II connector on the Decorator Somfy-Matic™ to the Master connector on the IGC or GCS II. Please refer to the IGC or GCS II instructions for further information.

OPERATING PROCEDURES

- Pressing the UP button will move the awning in, while the DOWN button will extend the awning when pressed. If a motor does not move in the correct direction, turn off the circuit breaker(s) and reverse the red and black wires at the corresponding motor(s). **FAILURE TO CORRECT THIS ERROR WILL CAUSE AWNING TO EXTEND DURING WINDY CONDITIONS AND MAY CAUSE SERIOUS DAMAGE.**
- Pressing the STOP button will stop the motor(s) in its present position.
- When the monitored sun intensity is greater than the DSM setting, the DOWN direction will activate after 3.5 minutes. The sun LED will remain on for as long as this condition exists. If the sun intensity is less than the DSM setting, the UP direction will activate after 12 minutes (if the auto LED is illuminated). The sun LED will blink during this period.
- When the monitored wind speed is greater than the DSM setting, the UP direction will activate after 2 seconds. The wind LED will remain on as long as this condition exists. When the wind speed drops below the set value, the DSM will return to normal mode after 15 minutes. The wind LED will blink and the motors are prevented from operating during this period.
- When the AUTO button is pressed, the AUTO LED will turn on or off depending on its previous status. Manual mode is designated by the LED being off. If the DSM is in manual mode, the sun level has no influence on motor control. The wind speed is constantly monitored and acted on regardless of AUTO setting.

DSM WIRING DIAGRAM

CAUTION: Before continuing with the line voltage wiring instructions, the up and down limits of each motor should be set using the SOMFY tester cable (Cat. No. 6020086). Refer to limit switch instructions packaged with each SOMFY motor for more information.

NOTE: When using a GCS II, the sun and wind sensors can be connected to the GCS II instead of the DSM if convenient.

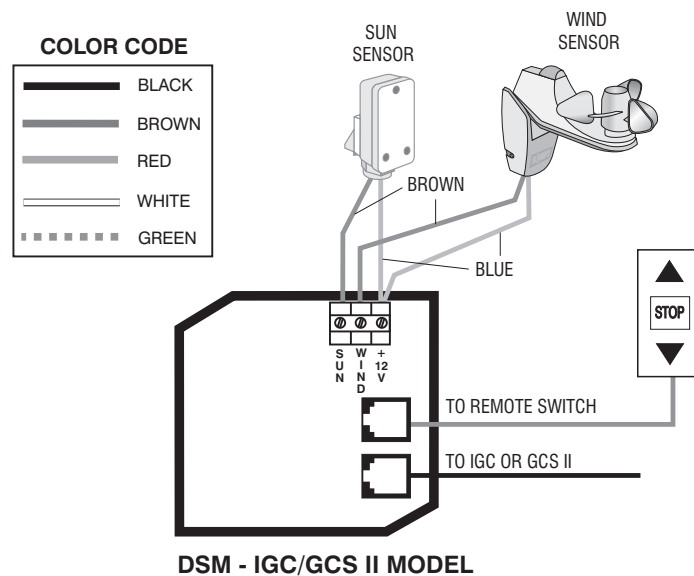
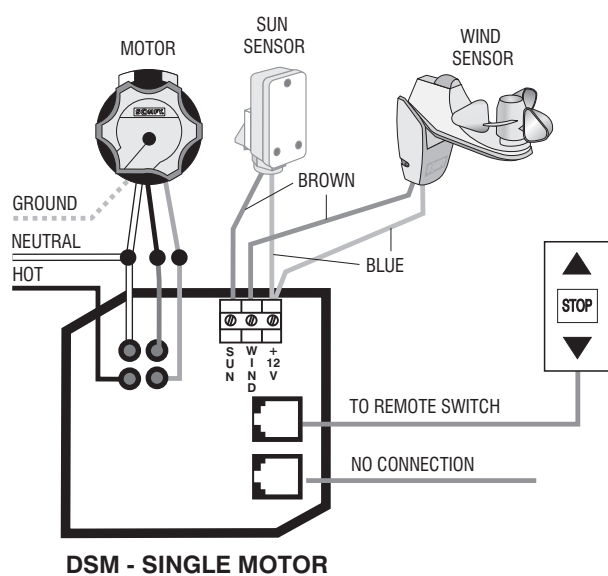

ORDERING INFORMATION

Description

Catalog Number

DSM - Single Motor	6300899 (White) 6300929 (Ivory)
DSM - IGC	6300895 (White) 6300925 (Ivory)
DSM - GCS II	6300903 (White) 6300933 (Ivory)

OPTIONS

Wind Sensor	6150545
Sun Sensor and Bracket	6300415
Enclosure for Surface Mount Option (Single Motor)	5670608
Enclosure for Surface Mount Option (IGC/GCS II)	5670609
Optional Switch	6300908 (White) 6300937 (Ivory)
Radio Remote Kit	6300448

DECORATOR SOMFY-MATIC™ OUTDOOR PLUG-IN SYSTEM

DESCRIPTION

The Outdoor Decorator Somfy-Matic™ (DSM) enables a retractable awning to provide shading from the sun and protection from the wind automatically and conveniently. The sun and wind sensors continually monitor sun intensity and wind speed. These settings can be adjusted from the faceplate and will trigger the control unit to extend or retract the awning as needed. The Outdoor DSM features advanced circuitry that assures factory preset accuracy and proven reliability. It helps protect furniture and carpeting from fading and saves on heating and air conditioning costs. The system is comprised of plug-in components, so installation is quick and simple.

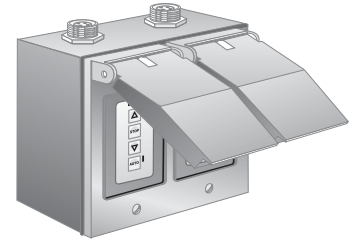

MECHANICAL SPECIFICATIONS

Overall Dimensions: L: 4 ⁵/₈ in. W: 4 ³/₈ in. D: 3 ¹/₂ in.

Operating Temperature Range: -20 °C to 50 °C (-5 °F to 120 °F).

Wind Speed: From 12 to 31 mph

ELECTRICAL SPECIFICATIONS

Voltage Rating:

INPUT: 115 VAC +/- 10%, 50/60 Hz

OUTPUT: 115 VAC 1/4 HP 5A

Approvals: The Outdoor DSM is approved per UL508 for industrial controls (UL, cUL)
Complies with the National Electrical Code (NEC) Standard

INSTALLATION PROCEDURES

1. Mount the sun and wind sensor junction box in a concealed location such as under an eave.
2. Make sure that the sun sensor is mounted facing the sun and is not shaded by trees or other building structures. It should be mounted as high as possible. The detection angle is up to 100 degrees wide from the center of the sensor face.
3. The wind sensor should be placed close to the awning or shading system to make sure the wind speed is measured at the product. Guard against installing the wind sensor too close to an obstruction such as a chimney, gutter or the awning itself, as this may block the wind and cause erroneous readings.
4. Connect the motor cable to the 4-conductor receptacle on the top of the control box. The sensor cable connects to the 3-conductor receptacle.
5. Plug the power cable into a weatherproof receptacle.

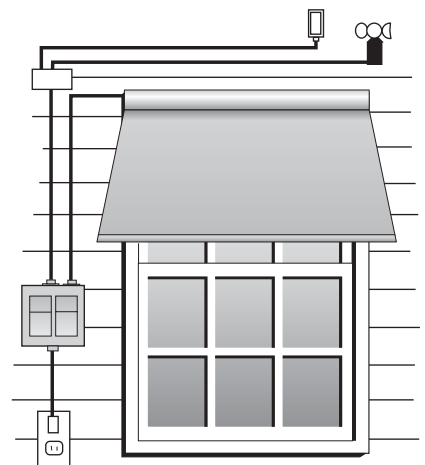

Left Motor Mount Shown

WIRING DIAGRAM

NOTE: Motor must be ordered with weatherproof plug

CAUTION: Before continuing with the line voltage wiring instructions, the up and down limits of each motor should be set using the SOMFY tester cable (Cat. No. 6020086). Refer to limit switch instructions packaged with each SOMFY motor for more information.

Right Motor Mount Shown

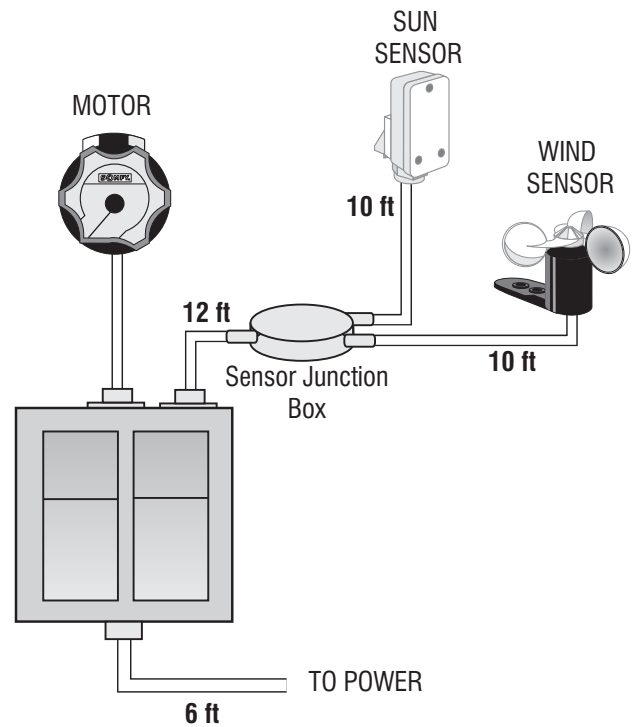

OPERATING PROCEDURES

- Pressing the UP button will move the awning in, while the DOWN button will extend the awning when pressed. If the motor does not move in the correct direction, the incorrect model Outdoor DSM is installed. The appropriate model Outdoor DSM must be obtained. **FAILURE TO CORRECT THIS ERROR WILL CAUSE AWNING TO EXTEND DURING WINDY CONDITIONS AND MAY CAUSE SERIOUS DAMAGE.**
- Pressing the STOP button will stop the motor in its present position.
- When the monitored sun intensity is greater than the Outdoor DSM setting, the DOWN direction will activate after 4 minutes. The sun LED will remain on for as long as this condition exists. If the sun intensity is less than the Outdoor DSM setting, the UP direction will activate, after 12 minutes (if the auto LED is illuminated). The sun LED will blink during this period.
- When the monitored wind speed is greater than the Outdoor DSM setting, the UP direction will activate after 2 seconds. The wind LED will remain on as long as this condition exists. When the wind speed drops below the set value, the Outdoor DSM will return to normal mode after 15 minutes. The wind LED will blink and the motors will not operate during this time period.
- When the AUTO button is pressed, the AUTO LED will turn on or off depending on its previous status. Manual mode is designated by the LED being off. If the Outdoor DSM is in manual mode, the sun level has no influence on motor control. The wind speed is constantly monitored and acted on regardless of AUTO setting.

ORDERING INFORMATION

Description	Catalog Number	Description	Catalog Number
Outdoor DSM - Left Motor Mount	6300980	6 Ft. Plug-in Cable Installed on LT Motor	6180295
Outdoor DSM - Right Motor Mount	6300981	6 Ft. Plug-in Cable Installed on LT CMO Motor	6180296
6 Ft. Plug-in Power Cord	6020387	6 Ft. Plug-in Motor Cable Extension	6020391
6 Ft. Plug-in Power Cord Extension	6020396		

DECORATOR COMFORT CONTROL (DCC)

DESCRIPTION

The Decorator Comfort Control (DCC) enables a window treatment to provide shading from the sun automatically and conveniently. The DCC sun sensor continually monitors sun intensity, triggering the control unit and motor to raise or lower the shades as needed.

The Decorator Comfort Control features advanced circuitry that assures factory preset accuracy and proven reliability. It helps protect furniture and carpeting from fading and saves on heating and air conditioning costs. With its sleek design, the DCC will complement any home decor. Combine this with the capability of being linked to SOMFY's Group Control and IGC systems, and you've got an extremely flexible product.

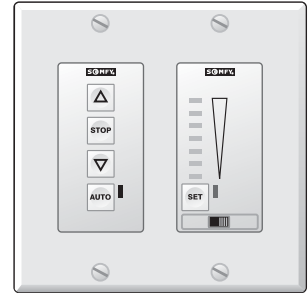

MECHANICAL SPECIFICATIONS

Overall Dimensions: L: 3 1/2 in. W: 2 3/4 in. D: 1 1/3 in.

Operating Temperature Range: -20° C to 50° C (-5° F to 120° F)

Fits in most 2 gang electrical boxes

ELECTRICAL SPECIFICATIONS

Voltage Ratings:

Single Motor:

INPUT: 120 VAC +/- 10% 50/60 Hz.

OUTPUT: 120 VAC 5A 1/4 HP

IGC/GCS:

INPUT: 12 - 15 VDC 150mA (Supplied by IGC or GCS)

OUTPUT: 12 - 15 VDC 150mA (Open Collector)

Approvals:

The DCC Single Motor Control is approved per UL508 for industrial controls (UL, cUL)

Complies with the National Electrical Code (NEC) Standard

INSTALLATION PROCEDURES

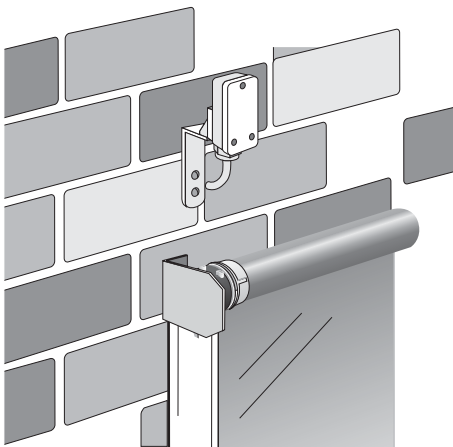

1. Make sure the sun sensor is mounted outside, facing the sun and is not shaded by trees or other building structures. It should be mounted as high as possible, no more than 100 feet from the Decorator Comfort Control. The detection angle is up to 100 degrees wide from the center of the sensor face. Connect the sensor wires to the terminal block as shown in the diagram on the next page.
2. For the Single Motor model, connect the motor wires to the DCC as illustrated.
3. For the IGC/GCS II models, using appropriate length modular cable, connect from the IGC/GCS II connector on the Decorator Comfort Control to the Master connector on the IGC or GCS II. Please refer to the IGC or GCS II instructions for further information.

OPERATING PROCEDURES

- Pressing the UP button will move the window covering up. Pressing the DOWN button will lower it when pressed. If a motor does not move in the correct direction, turn off the circuit breaker(s) and reverse the red and black wires at the corresponding motor(s).
- Pressing the STOP button will stop the motor in its present position.
- When the monitored sun intensity is greater than the DCC setting, the DOWN direction will activate after 3.5 minutes. The sun LED will remain on for as long as this condition exists. If the sun intensity is less than the DCC setting, the UP direction will activate after 15 minutes (if the auto LED is illuminated). The sun LED will blink during this time period.
- When the AUTO button is pressed, the AUTO LED will turn on or off depending on its previous status. Manual mode is designated by the LED being off. If the DCC is in manual mode, the sun level has no influence on motor control.
- With the Summer/Winter switch in the SUMMER position (to the left), the Decorator Comfort Control sun functions will operate as outlined above. When the switch is in the WINTER position (to the right) the Decorator Comfort Control sun functions will operate in the opposite directions.

DCC WIRING DIAGRAMS

CAUTION: Before proceeding with the line voltage wiring instructions, the up and down limits of each motor should be set using the SOMFY tester cable (Cat. No. 6020086). Refer to limit switch instructions packaged with each SOMFY motor for more information.

NOTE: When using a GCS II, the sun sensor can be connected to the GCS II instead of the DCC if convenient.

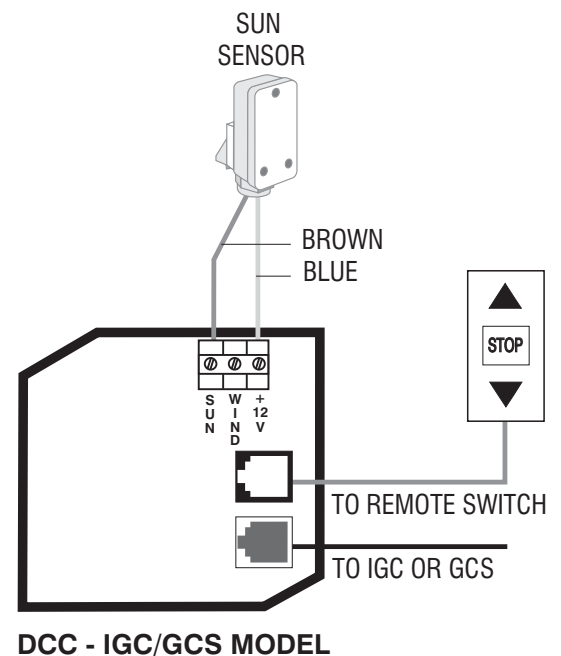
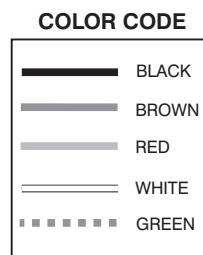
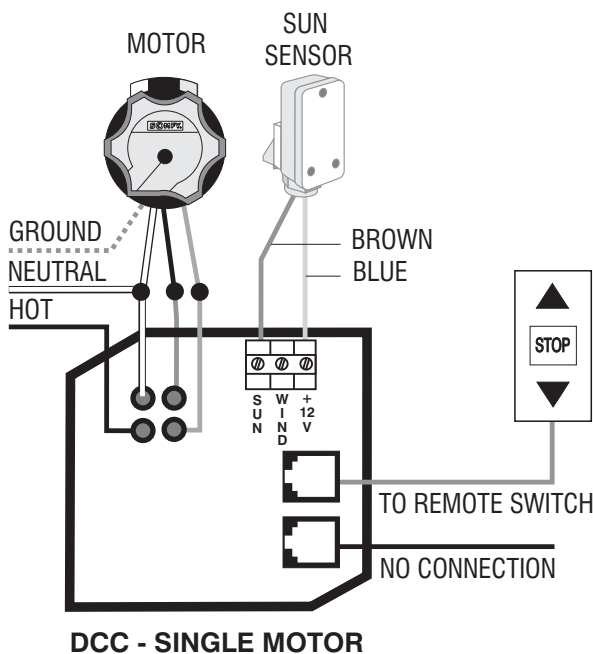

ORDERING INFORMATION

Description

DCC - Single Motor
DCC - IGC
DCC - GCS II

Catalog Number

6300901 (White) 6300931 (Ivory)
6300897 (White) 6300927 (Ivory)
6300905 (White) 6300935 (Ivory)

OPTIONS:

Sun Sensor and Bracket
Enclosure for Surface Mount Option (Single Motor)
Enclosure for Surface Mount Option (IGC/GCS II)
Optional Switch
Radio Remote Kit

6300415
5670608
5670609
6300908 (White) 6300937 (Ivory)
6300448

WIND-A-MATIC II

DESCRIPTION

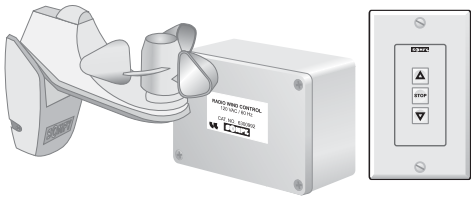

The SOMFY Wind-a-Matic II is a single motor control designed for residential use. The unit features a wind sensor and an elegant indoor switch. Wind speed is continuously monitored, triggering the control to retract awnings or lower shutters automatically as needed. This control is packaged in a weatherproof enclosure and includes watertight strain-relief fittings for wires entering the box. The Wind-a-Matic II is ideal for both new construction and home improvement, installing fast and easy near the motor and reducing overall wiring costs.

MECHANICAL SPECIFICATIONS

Overall Dimensions: L: 4 ⁵/₈ in. W: 4 ⁵/₈ in. D: 2 ¹/₂ in.

Wind Speed: 12 to 31 mph

Operating Temperature Range: -20 ° to 50 ° Celsius

ELECTRICAL SPECIFICATIONS

Voltage Ratings:

INPUT:	120 VAC +/- 10%	50/60 Hz.
OUTPUT:	120 VAC 5A	1/4 HP

Approvals:

The Wind-A-Matic II is UL508 (pending) for industrial controls (UL, cUL)
Complies with the National Electrical Code (NEC) Standard

INSTALLATION PROCEDURES

1. The Wind-a-Matic-II should be mounted as close to the motor as possible. If mounted outside, ensure that the connections are facing down to avoid moisture seepage.
2. Connect high and low voltage wires according to the wiring diagram on the next page. Make sure to use included watertight strain relief fittings to maintain the weatherproofing of the enclosure.
3. The wind sensor should be placed close to the awning or shading system to make sure the wind speed is measured at the product. Guard against installing the wind sensor too close to an obstruction such as a chimney, gutter or the awning itself, as this could block the wind and cause erroneous sensor readings. The sensor should not be more than 100 feet from the control.
4. Connect the low voltage switch according to the diagram on the next page. It should be mounted no more than 100 feet from the Wind-a-Matic-II.

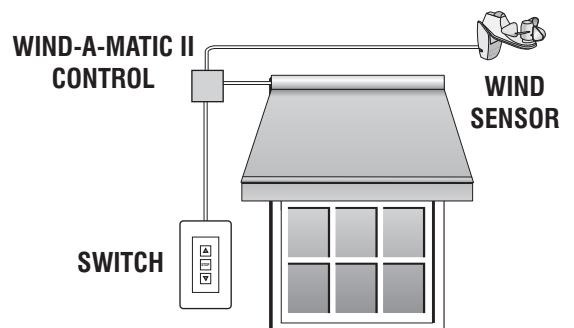
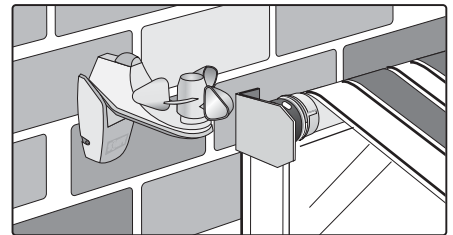

WIRING DIAGRAM

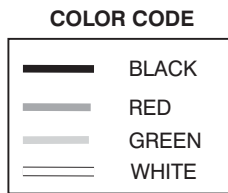

CAUTION:
Mount control with fittings facing downward.

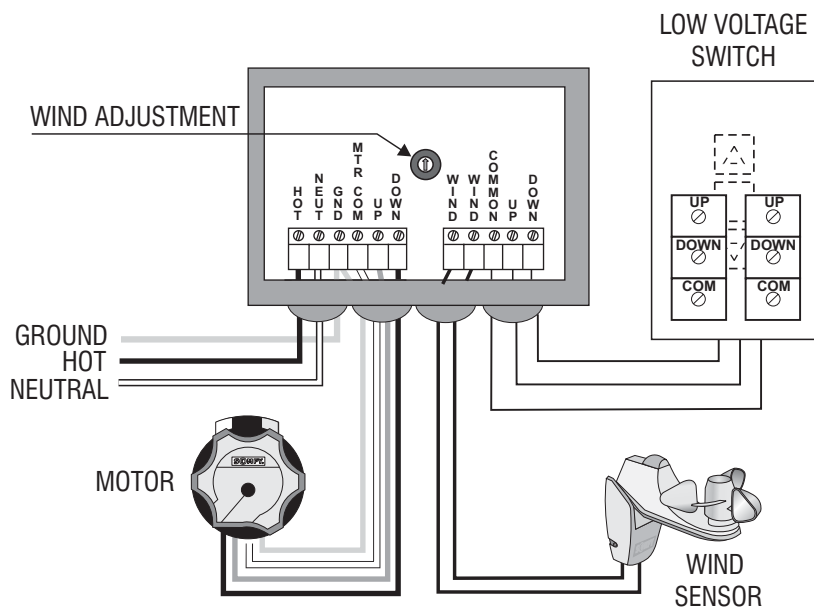

OPERATING INSTRUCTIONS

System Power Up

1. With power off, wire the Wind-a-Matic II as indicated above. Turn all circuit breakers on (motors should not move).
2. Operate each motor in the DOWN direction using the low voltage switch. The motorized covering should move down or out. If this is incorrect, turn off the circuit breakers and reverse the red and black wires of the motor.

FAILURE TO CORRECT THIS ERROR WILL CAUSE AWNING TO EXTEND DURING WINDY CONDITIONS AND MAY CAUSE SERIOUS DAMAGE.

Setting The Wind Level

1. To change the wind sensitivity, simply rotate the wind adjustment knob to the desired setting.

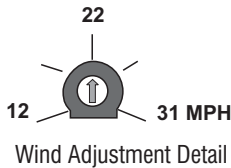

Operating Procedures

1. Pressing the UP button on the low voltage switch will move the window covering up or in.
2. To stop the motorized covering at any time, press the STOP button.
3. When the monitored wind speed is greater than the Wind-a-Matic II setting, the UP direction will activate after 2 seconds. As long as the wind speed remains high, all other commands will be ignored.
4. When the wind speed drops below the set value, the Wind-a-Matic II control will return to normal operation following a 15 minute delay.

ORDERING INFORMATION

Description	Catalog Number
Wind-a-Matic II Kit (control, wind sensor and switch)	6300998
Wind-a-Matic II (control only)	6300990
IGC Switch w/Terminals - White	6300040
IGC Switch w/Terminals - Ivory	6300140

EOLIS RECEIVER

Inteo Wind-Remote Control

DESCRIPTION

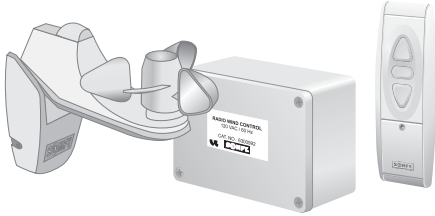

The SOMFY Eolis Receiver is a single motor control designed for residential use. It includes an integrated radio receiver, wind sensor and low voltage switch inputs. Wind speed is continuously monitored, triggering the control to retract awnings, rolling shutters or exterior screens automatically as needed. Using the single or four-channel Telis Transmitters, it is possible to operate the controls individually or in groups. Two user-defined intermediate positions can be programmed. This new control is packaged in a weatherproof enclosure and includes watertight strain-relief fittings for wires entering the box.

MECHANICAL SPECIFICATIONS

Overall Dimensions: L: 6 in. W: 4 1/4 in. D: 2 1/4 in.

Wind Speed: 12 to 31 mph

Frequency Range (optimal conditions): 65 ft.

ELECTRICAL SPECIFICATIONS

Voltage Ratings:

INPUT:	120 VAC +/- 10%	50/60 Hz.
OUTPUT:	120 VAC 5A	1/4 HP

Approvals:

The Eolis Receiver is UL508 for industrial controls (UL, cUL)
Complies with the National Electrical Code (NEC) and
FCC Standards

INSTALLATION PROCEDURES

1. The Eolis Receiver should be mounted as close to the motor as possible. If mounted outside, ensure that the connections are facing down to avoid moisture seepage. Avoid mounting the control against any metallic surface, as this may affect radio reception.
2. Connect high and low voltage wires according to the wiring diagram on the next page. It is recommended that the low voltage wiring is done first, for easier access to the terminals. Make sure to use included watertight strain relief fittings to maintain the weatherproofing of the enclosure.
3. The wind sensor should be placed close to the awning or shading system to make sure the wind speed is measured at the product. Guard against installing the wind sensor too close to an obstruction such as a chimney, gutter or the window covering itself, which could block the wind and cause erroneous sensor readings. The sensor should not be more than 100 feet from the control.
4. When using a low voltage switch, it should be located no more than 100 feet from the Eolis Receiver.

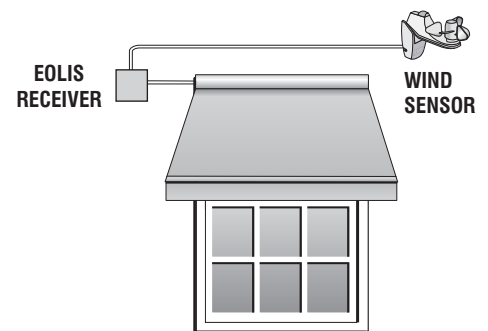
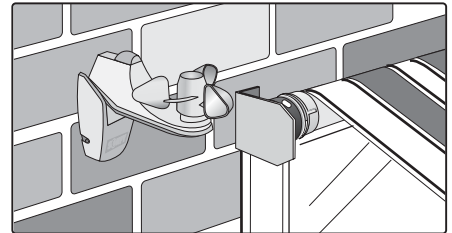

WIRING DIAGRAM

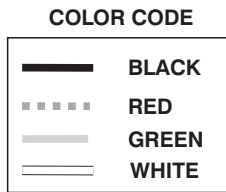

CAUTION:
Mount control with fittings facing downward!

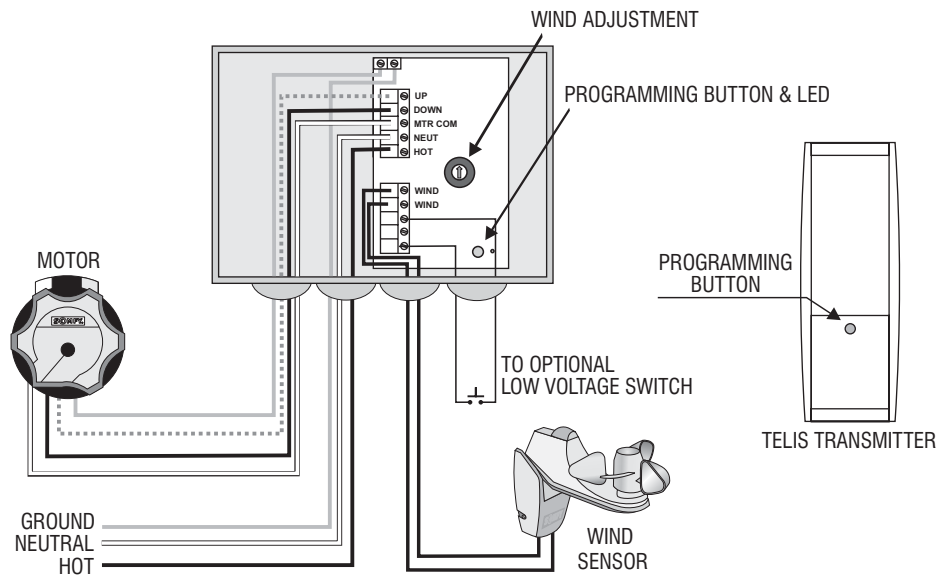

OPERATING INSTRUCTIONS

System Set Up

1. With power off, wire the Eolis Receiver as indicated above. Turn all circuit breakers on (motors should not move).
2. Set the Eolis Receiver into programming mode by pressing the programming button on the receiver until the LED lights (about 5 seconds).
3. Press the programming button on the Telis1 or Telis4 transmitter. Make sure the desired channel is selected on the Telis4 before programming. The programming LED on the Eolis Receiver will blink indicating the transmitter has been memorized.
4. Operate each motor in the DOWN direction using the radio transmitter. The motorized product should move down or out. If this is incorrect, turn off the circuit breakers and reverse the red and black wires of the motor. **FAILURE TO CORRECT THIS ERROR WILL CAUSE AWNING TO EXTEND DURING WINDY CONDITIONS AND MAY CAUSE SERIOUS DAMAGE.**

Setting The Wind Level

1. To change the wind sensitivity, simply rotate the wind adjustment knob to the desired setting.

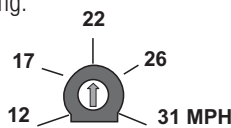

Wind Adjustment Detail

Operating Procedures

TRANSMITTER

1. Pressing the UP button on the Telis transmitter will move the window treatment up or in. The DOWN button will move the exterior screen or awning down or out.
2. To stop the motorized window covering at any time, press the CENTER button on the transmitter.
3. To reach one of the intermediate positions, the awning or exterior screen must first be stopped at the upper or lower limit. Pressing the center button on the transmitter will move the window covering to the desired position.

WIND FUNCTION

4. When the monitored wind speed is greater than the setting, the UP direction will activate after 2 seconds. As long as the wind speed remains high, all other commands will be ignored.
5. When the wind speed drops below the set value, the Eolis Receiver will return to normal operation following a one minute delay.

LOW VOLTAGE SWITCH

6. If desired, a single pole, single throw switch can be connected to the low voltage terminals as indicated above. Each press of the switch will sequence through the directions as follows:

DEPRESS 1	UP DIRECTION
DEPRESS 2	STOP
DEPRESS 3	DOWN DIRECTION
DEPRESS 4	STOP

ORDERING INFORMATION

Description	Catalog Number	Description	Catalog Number
Eolis Receiver Kit (control & wind sensor)	6301022	Telis Transmitter	6301014
Eolis Receiver (control only)	6301028	Telis4 Transmitter	6301015
Eolis Sensor	6150545	Decorator RTS Switch	6301033 (White), 6301034 (Ivory)
SPST Momentary Switch	6300080 (White)	Decorator RTS Switch (4 Channel)	6301025 (White), 6301035 (Ivory)
		Chronis RTS Timer	6300383

SOLIRIS RECEIVER

Inteo Sun & Wind-Remote Control

DESCRIPTION



The SOMFY Soliris Receiver enables a motorized awning or exterior screen to provide shading from the sun and protection from the wind automatically and conveniently. The Soliris combined sun and wind sensor continually monitors sun intensity and wind speed, triggering the control unit to extend or retract an awning as needed. It includes an integrated radio receiver that makes it possible to operate the controls individually or in groups, using the Telis transmitters. Two user-defined intermediate positions can be programmed. This control is packaged in a weatherproof enclosure and includes watertight strain-relief fittings for wires entering the box.

MECHANICAL SPECIFICATIONS

Overall Dimensions: L: 6 in. W: 4 1/4 in. D: 2 1/4 in.

Frequency Range (Optimal Conditions): 65 ft.

Wind Speed: 12 to 31 mph

ELECTRICAL SPECIFICATIONS

Voltage Ratings:

INPUT:	120 VAC +/- 10%	50/60 Hz
OUTPUT:	120 VAC 5A	1/4 HP

Approvals: The Soliris Receiver is UL508 for industrial controls (UL, cUL)

Complies with the National Electrical Code (NEC) and FCC Standards



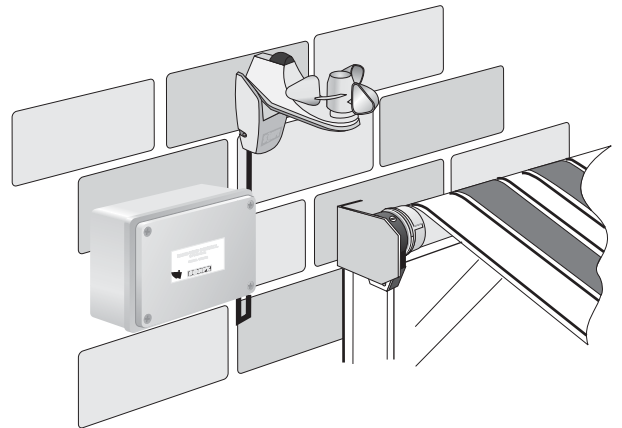

INSTALLATION PROCEDURES

1. The Soliris Receiver should be mounted as close to the motor as possible. If mounted outside, ensure that the connections are facing down to avoid rain seepage. Avoid mounting the control against any metallic surface, as this may affect radio reception.
2. Connect high and low voltage wires according to the wiring diagram on the next page. The low voltage wiring should be done first, to gain easier access to the terminals. Make sure to use included watertight strain relief fittings to maintain the weatherproofing of the enclosure.
3. The combined sensor should be placed close to the awning or shading system to make sure the wind speed is measured at the product. Guard against installing the wind sensor too close to an obstruction such as a chimney, gutter or the window covering itself, which could block the wind and cause erroneous sensor readings. The sensor should also not be mounted in the shade or be obstructed by trees, to ensure accurate sunlight readings. The sensor should not be more than 100 feet from the control.
4. When using a low voltage switch, it should be located no more than 100 feet from the Soliris Receiver.



WIRING DIAGRAM

COLOR CODE

	BLACK
	RED
	GREEN
	WHITE

CAUTION:
Mount control with fittings facing downward!

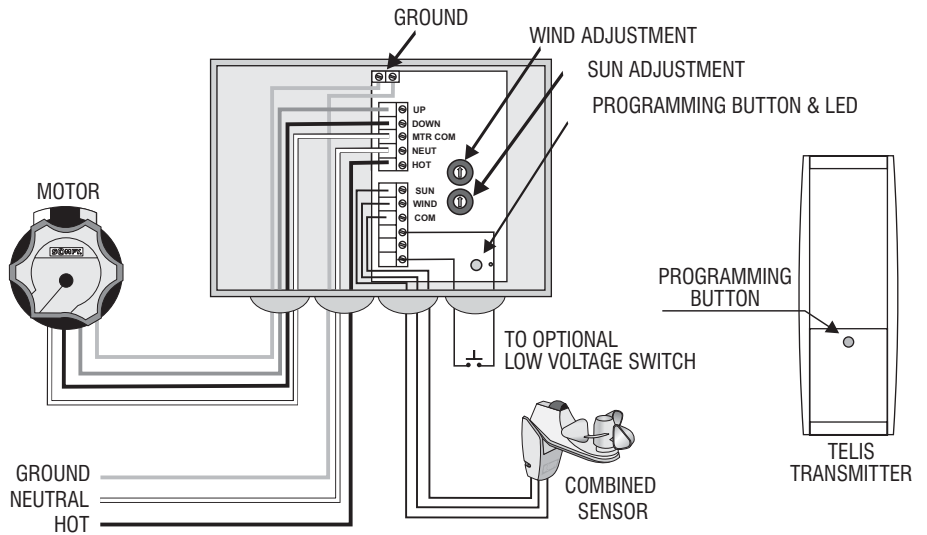

OPERATING INSTRUCTIONS

System Set Up

1. With power off, wire the Soliris Receiver as indicated. Turn all circuit breakers on (motors should not move).
2. Set the Soliris Receiver into programming mode by pressing the programming button until the LED lights (about 5 seconds). Press the programming button on the Telis1, Telis4 or Telis Soliris transmitter. The programming LED will blink indicating the transmitter has been memorized.
3. Operate each motor in the DOWN direction using the radio transmitter. The motorized product should move down or out. If this is incorrect, turn off the circuit breakers and reverse the red and black wires of the motor. **FAILURE TO CORRECT THIS ERROR WILL CAUSE DAMAGE TO AWNING BY EXTENDING IT DURING WINDY CONDITIONS.**

Setting The Wind Level

1. To change the wind sensitivity, simply rotate the wind adjustment knob to the desired setting. All time delays are reduced at the Installation Mode setting.

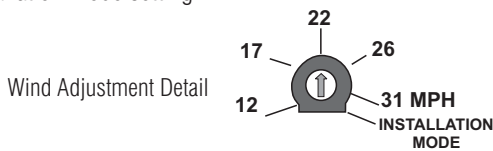

Setting The Sun Level

1. To change the sun sensitivity, simply rotate the sun adjustment knob to the desired setting.

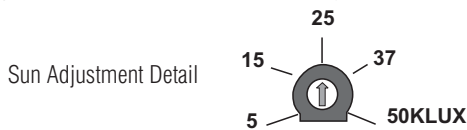

Operating Procedures

TRANSMITTER

1. Pressing the UP button on the Telis transmitter will move the exterior window covering up or in. The DOWN button will move it down or out.
2. To stop the motorized product at any time, press the CENTER button on the transmitter.
3. Pressing the SUN/WIND button on the Telis Soliris Transmitter will toggle between wind only and sun and wind operation. When the wind only function is selected, the Soliris Receiver will not activate according to the sun levels.

SUN FUNCTION

4. When the measured sun intensity is greater than the set level, a DOWN command is given.
5. When the sun intensity falls below the set level, the awning or exterior screen will retract automatically after a 20 minute delay.

WIND FUNCTION

6. When the monitored wind speed is greater than the setting, the UP direction will activate after 2 seconds. As long as the wind speed remains high, all other commands will be ignored.
7. When the wind speed drops below the set value, the Soliris Receiver will extend the awning automatically after a 12 minute delay. However, a manual command can be given with the radio transmitter after only one minute.

LOW VOLTAGE SWITCH

8. An optional single pole, single throw switch can be connected to the low voltage terminals. Each press of the switch will sequence through the directions as follows:

DEPRESS 1	UP DIRECTION
DEPRESS 2	STOP
DEPRESS 3	DOWN DIRECTION
DEPRESS 4	STOP

ORDERING INFORMATION

Description	Catalog Number	Description	Catalog Number
Soliris Receiver Kit (control & combined sensor)	6301024	Telis Transmitter	6301014
Soliris Receiver (control only)	6301029	Telis 4 Transmitter	6301015
Soliris Sensor	6150518	Decorator RTS Switch	6301033 (White), 6301034 (Ivory)
Telis Soliris Transmitter	6301017	Decorator RTS Switch (4 Channel)	6301025 (White), 6301035 (Ivory)
SPST Momentary Switch	6300080 (White)	Chronis RTS Timer	6300383

TELIS SOLIRIS TRANSMITTER

DESCRIPTION

The Telis Soliris Transmitter is a single channel hand-held transmitter compatible with the Soliris Receiver, Altus motor and Soliris RTS Sensor. It will operate window coverings at a distance as well as switch between Wind-Only or Sun & Wind Modes.



Catalog No: 6301017

MECHANICAL SPECIFICATIONS

Overall Dimensions: L: 4 ³/₄ in. W: 1 ³/₄ in. D: ³/₄ in.

Operating Temperature: 41°F to 104°F

Frequency Range (optimal conditions): 65 ft.

ELECTRICAL SPECIFICATIONS

Power: 3V Lithium batter, Cr2430

Frequency: 433.42 Mhz

GENERAL OPERATING INSTRUCTIONS

NOTE: Please Consult Altus Motor or Soliris Receiver Instructions for Specific Product Details.

1. Place the Altus Motor or Soliris Receiver in Programming Mode as described in the Operating Instructions.
2. Press the programming button on the back of the Telis Soliris to program it into the memory of the Altus Motor or Soliris Receiver.
3. Pressing the UP button will raise the window covering, while pressing the DOWN button will lower it. To stop the window covering, simply press the STOP button.
4. Pressing the Mode Selector button will switch between Wind-Only and Sun & Wind Modes. The corresponding LED will light to indicate the mode selected.

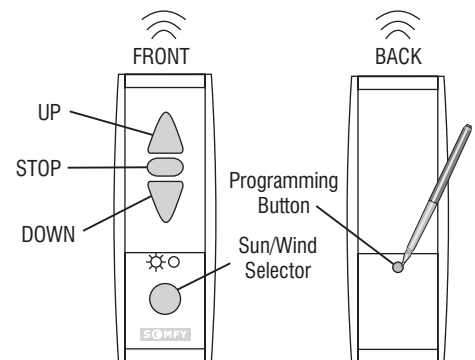

SOLIRIS & EOLIS RTS SENSOR

DESCRIPTION

The SOMFY Soliris RTS and Eolis RTS sensors are 24V radio sensors compatible with the Altus and LT CMO RTS motors. The Eolis is a wind only, while the Soliris is a combined sun and wind sensor. Sun intensity and wind speed thresholds can be set right on the sensor. The RTS Sensors will command the motor to extend or retract an awning as needed, via radio signal. It comes with a 24V DC transformer to provide power, otherwise additional wiring is not needed.

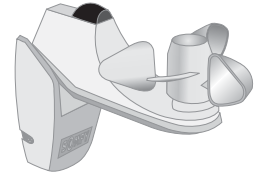

MECHANICAL SPECIFICATIONS:

Overall Dimensions: L: 9 1/3 in. H: 6 1/3 in.

Frequency Range (optimal conditions): 65 ft.

Cable Lengths: Transformer to Sensor; 30 ft.
Transformer to Power; 6 ft.

ELECTRICAL SPECIFICATIONS:

Power: 24V DC, 20mA (Class 2 transformer)

Frequency: 433.42 Mhz

INSTALLATION

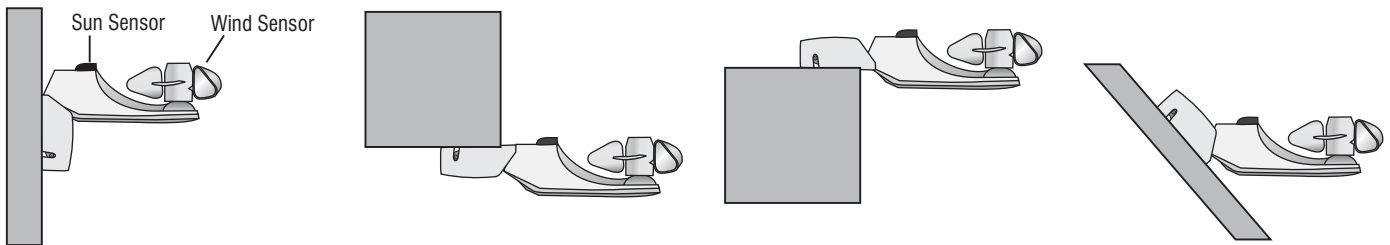

GENERAL OPERATING INSTRUCTIONS





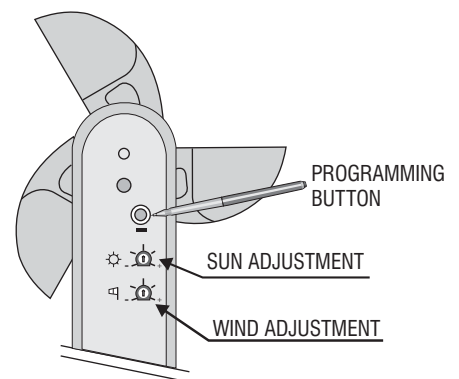



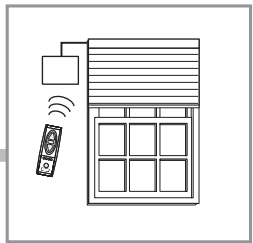

NOTE: Please Consult Motor Instructions for Specific Product Details.

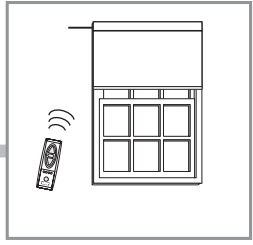
1. Place the Altus or CMO RTS Motor in Programming Mode as described in the Operating Instructions.
2. Press the programming button on the back of the Soliris or Eolis RTS Sensor to program it in the memory of the motor.
3. When the measured wind speed exceeds the threshold set on the RTS Sensor, an UP command is transmitted after 2 seconds. As long as the measured wind speed is greater than the threshold, all other commands will be ignored. Once the measured wind speed falls below the threshold, the exterior window covering can be operated with a Telis transmitter after a 30 second delay. With the Soliris RTS Sensor, the sun will automatically activate the motor after a 12 minute delay.
4. When the measured sun intensity exceeds the threshold set on the Soliris RTS Sensor, a DOWN command is transmitted after 2 minutes. After approximately a 20 minute delay, if the sun intensity falls below the threshold, an UP command will be transmitted.

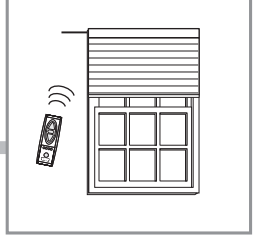
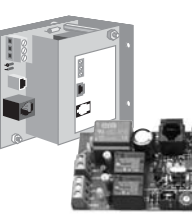
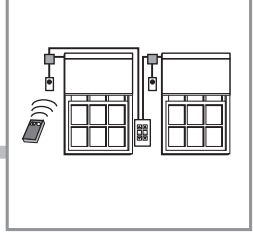

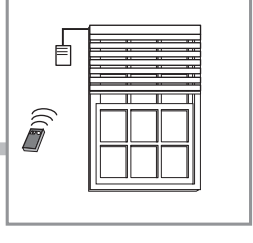
ORDERING INFORMATION

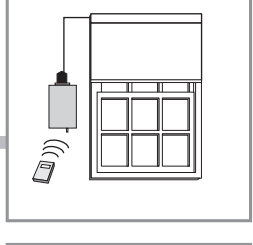
Description	Catalog Number	Description	Catalog Number
Eolis RTS Sensor Kit (Sensor & Transformer)	6301050	Eolis RTS Sensor	6150546
Soliris RTS Sensor Kit	6301051	Soliris RTS Sensor	6150519
		Transformer, 24VDC 20mA	5700000

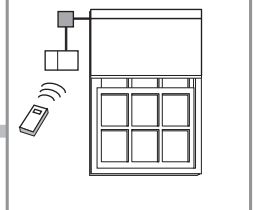
	<p><i>Centralis</i> 54</p>	
	<p><i>RTS 25 DC Control</i> 56</p>	
	<p><i>Telis 1 & 4 Channel Transmitters</i> 57 <i>Radio Headrail Control (HRC-RF)</i> 58</p>	
	<p><i>Multi-Channel Infrared Control (MCIR)</i> 60 <i>Infrared Headrail Control (HRC-IR)</i> 62</p>	
	<p><i>IRS 300 Infrared Control</i> <i>for DC Motors</i> 64</p>	
	<p><i>Wireless Command II</i> 66</p>	
	<p><i>Single Motor Remote</i> 68 <i>3N1 Remote Control</i> 71</p>	

CENTRALIS RECEIVER

Inteo Remote Control

DESCRIPTION



The new SOMFY Centralis Receiver is a single motor control designed for residential use. It includes an integrated radio receiver, plus input terminals for an optional low voltage switch. Using the Telis Transmitters, it is possible to operate the controls individually or in groups. Two user-defined intermediate positions can be programmed. This new control is packaged in a weatherproof enclosure and includes watertight strain-relief fittings for wires entering the box.

MECHANICAL SPECIFICATIONS

Overall Dimensions:

L: 6 in. W: 4 1/4 in. D: 2 1/4 in.

Typical Range (Optimal Conditions): 65 ft.

ELECTRICAL SPECIFICATIONS

Voltage Ratings:

INPUT: 120 VAC +/- 10% 50/60 Hz.

OUTPUT: 120 VAC 5A 1/4 HP

Approvals: The Centralis Receiver is UL508 for industrial controls (UL, cUL) Complies with the National Electrical Code (NEC) and FCC Standards

INSTALLATION PROCEDURES

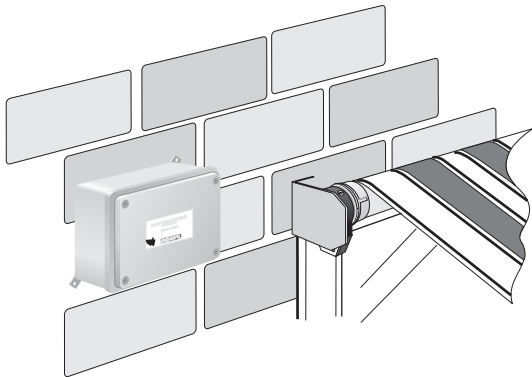





1. The Centralis Receiver should be mounted as close to the motor as possible. If mounted outside, ensure that the connections are facing down to avoid rain seepage. Avoid mounting the control against any metallic surface, as this may affect the radio reception.
2. Connect high and low voltage wires according to the wiring diagram on the next page. It is recommended that the low voltage wiring is done first, for easier access to the terminals. Make sure to use included watertight strain relief fittings to maintain the weatherproofing of the enclosure.
3. When using a low voltage switch, it should be located no more than 100 feet from the Centralis Receiver.

ORDERING INFORMATION

Description	Catalog Number	Description	Catalog Number
Centralis Receiver	6301023	Decorator RTS Switch	6301033 (White), 6301034 (Ivory)
Telis Transmitter	6301014	Decorator RTS Switch (4 Channel)	6301025 (White), 6301035 (Ivory)
Telis4 Transmitter	6301015	Chronis RTS Timer	6300383
SPST Momentary Switch (White)	6300080		

WIRING DIAGRAM

COLOR CODE	
	BLACK
	RED
	GREEN
	WHITE

NOTE:
Mount control with fittings
facing downward!

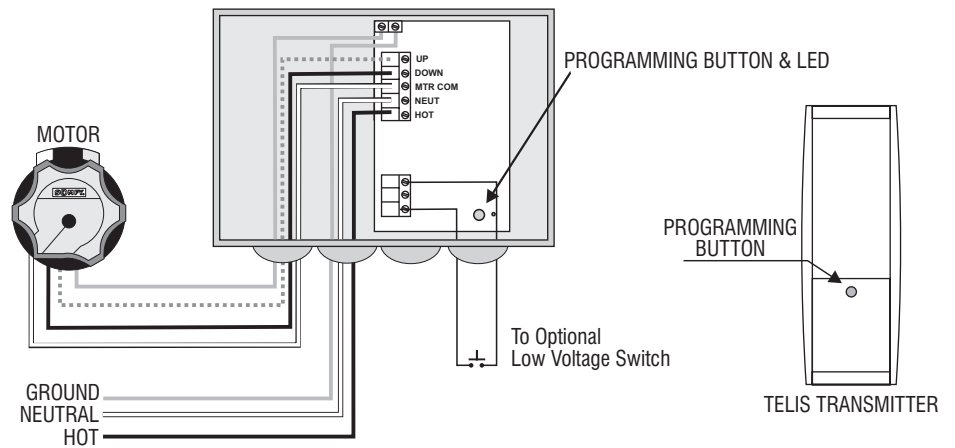

OPERATING INSTRUCTIONS

System Set Up

1. With power off, wire Centralis as indicated above. Turn all circuit breakers on (motors should not move).
2. Set the Centralis Receiver into programming mode by pressing the programming button on the receiver until the LED lights (about 5 seconds).
3. Press the programming button on the Telis1 or Telis4 transmitter. Make sure the desired channel is selected on the Telis4 before programming. The programming LED on the Centralis will blink indicating the transmitter has been memorized.
4. Operate each motor in the DOWN direction using the radio transmitter.
5. The motorized window covering should move down or out. If this is incorrect, turn off the circuit breakers and reverse the red and black wires of the motor.

Operating Procedures

TRANSMITTER

1. Pressing the UP button on the Telis transmitter will move the window covering up or in. The DOWN button will move the treatment down or out.
2. To stop the motorized product at any time, press the CENTER button on the transmitter.
3. To reach one of the intermediate positions, the awning or rolling shutter must first be at the upper or lower limit, and stopped. Pressing the center button on the transmitter will move the window covering to the desired position.

LOW VOLTAGE SWITCH

4. If desired, a single pole, single throw switch can be connected to the low voltage terminals as indicated above. Each press of the switch will sequence through the directions as follows;

DEPRESS 1	UP DIRECTION
DEPRESS 2	STOP
DEPRESS 3	DOWN DIRECTION
DEPRESS 4	STOP

PROGRAMMING PROCEDURES

RECORDING THE INTERMEDIATE POSITION FROM THE TOP OF THE WINDOW TREATMENT

- Bring the window covering to its upper limit using the Telis transmitter. Press the DOWN and CENTER buttons simultaneously until the awning begins to move, then release.
- Stop the window covering at the intermediate position desired. Press the CENTER button for 2 seconds to memorize that position.

RECORDING THE INTERMEDIATE POSITION FROM THE BOTTOM OF THE WINDOW TREATMENT

- Bring the motorized product to its lower limit. Press the UP and CENTER buttons simultaneously until the window covering begins to move, then release.
- Stop the window covering at the position desired. Press the CENTER button for 2 seconds to memorize that position.

DELETING AN INTERMEDIATE POSITION

- Briefly press the CENTER button of the Telis transmitter to reach the desired intermediate position.
- Continue to press the CENTER button for 10 seconds until the programming LED on the Centralis Receiver stops blinking. That position is now deleted.

TO ADD A NEW TRANSMITTER TO THE MEMORY OF THE RECEIVER

- Press the programming button, for more than 2 seconds, on a transmitter that is already memorized by the Centralis Receiver to wake up the receiver. The programming LED on the Centralis will light. Press the programming button on the new transmitter to attach it to the Centralis Receiver.

TO REMOVE A TRANSMITTER FROM THE MEMORY OF THE RECEIVER

- Press the programming button on the Centralis Receiver until the LED lights. Quickly press the programming button on the transmitter you want to remove.

TO REMOVE ALL TRANSMITTERS FROM THE MEMORY OF THE RECEIVER (Resetting of the Centralis Receiver)

- Press the programming button of the Centralis Receiver until the LED blinks. This removes ALL memorized transmitters.

RTS25 - DC

DESCRIPTION



SOMFY'S RTS25-DC radio controls for 24VDC motors is available for internal and external headrail mounting. Both provide lift, tilt, and intermediate stop functions for a variety of interior window covering applications. Remote control is possible through the use of SOMFY's Telis 1 & Telis 4 radio remote transmitters, wireless Decorator RTS wall switches, or Chronis RTS timer.

MECHANICAL SPECIFICATIONS

Overall Dimensions: Headrail Mount: L: 3 1/2 in D: 9/10 in
External Mount: L: 5 1/4 in W: 1 in D: 1 in

Typical Range (Optimal Conditions): 65 ft.

ELECTRICAL SPECIFICATIONS

Voltage Ratings: INPUT: 24V DC
OUTPUT: 24V DC 1.3A

Approvals: Complies with the National Electrical Code Standards (NEC).

WIRING DIAGRAM

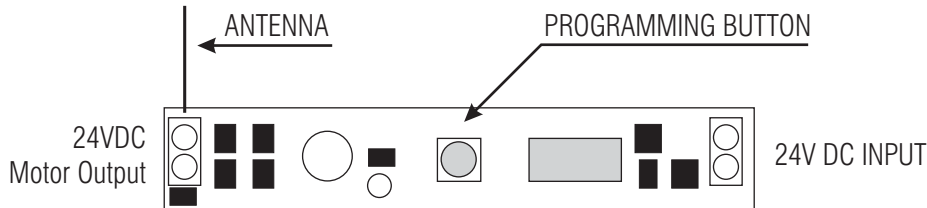

ORDERING INFORMATION

Description

RTS25 DC - Headrail mount
RTS25 DC - External mount
Transformer, 24V DC 1A
Transformer, 24V DC 2A
Telis Transmitter
Telis4 Transmitter
Decorator RTS Switch
Decorator RTS Switch (4 Channel)
Chronis RTS Timer

Catalog Number

6300025
6300026
5700093
5700096
6301014
6301015
6301033 (White), 6301034 (Ivory)
6301025 (White), 6301035 (Ivory)
6300383



Cat. No. 6301033



Cat. No. 6301015

TELIS TRANSMITTERS

DESCRIPTION

The Telis Transmitters (single or four channel) are hand-held radio transmitters compatible with RTS Motors and external RTS receivers such as Centralis or HRC-RF. Each transmitter can operate any number of motors or receivers, while each motor or receiver will memorize up to 12 transmitters. The four channel transmitter can be used for group and individual control of window treatments.



MECHANICAL SPECIFICATIONS

Overall Dimensions: L: 4 $\frac{3}{4}$ in. W: 1 $\frac{3}{4}$ in. D: $\frac{3}{4}$ in.

Operating Temperature: 41°F to 104°F

Typical Range (Optimal Conditions): 65 ft.

ELECTRICAL SPECIFICATIONS

Power: 3V Lithium battery, Cr2430

Frequency: 433.42 Mhz

GENERAL OPERATING INSTRUCTIONS

NOTE: Please Consult RTS Motor or Receiver Instructions for Specific Product Details.

1. Place the RTS Motor or Receiver in Programming Mode as described in the Operating Instructions.
2. Press the programming button on the back of the Telis transmitter to program it in the memory of the RTS Motor or Receiver.
3. Pressing the UP button will raise the window covering, while pressing the DOWN button will lower it. To stop the window covering, simply press the STOP button.
4. Pressing the Channel Selector button on the four channel transmitter will switch between channels 1 through four and the group (or fifth) channel. The corresponding LEDs will light to indicate the channel selected.

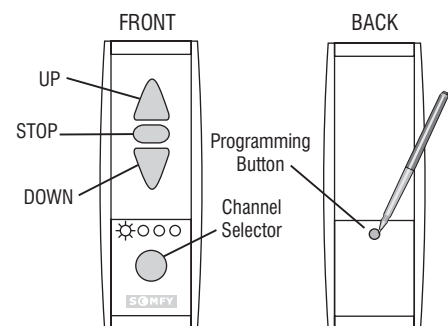

ORDERING INFORMATION

Description	Catalog Number
Telis Transmitter (Single Channel)	6301014
Telis4 Transmitter (Four Channel)	6301015

HEADRAIL CONTROL - RF (HRC-RF)

DESCRIPTION

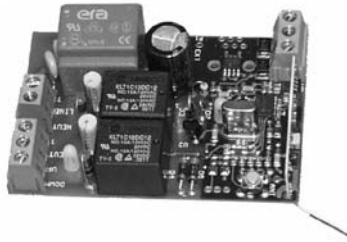

SOMFY'S Headrail Radio Remote Control is specially designed to mount inside an industry standard 2"x2" headrail. It is capable of both lift and tilt functions for a variety of interior window covering applications. Remote control is possible through the use of SOMFY's Telis1 and Telis4 transmitters or Decorator RTS switches. In addition, a low voltage switch can be connected to control the window covering with a push of a button.

MECHANICAL SPECIFICATIONS

Overall Dimensions:

L: 3 ¹/₆ in. W: 2 ¹/₆ in. D: 1 ²/₅ in.

Typical Range (Optimal Conditions): 65 ft.

ELECTRICAL SPECIFICATIONS

Voltage Ratings: INPUT: 115 VAC +/- 10% 50/60 Hz
OUTPUT: 115 VAC 5A 1/4 HP

Approvals: Complies with the National Electrical Code Standards (NEC).
UR, cUR approved

PROGRAMMING INSTRUCTIONS

- * All programming must be done with the transmitter placed as close as possible to the HRC-RF. If more than one control is to be programmed, it is recommended that power be applied to only the control being programmed.
- * The HRC-RF can store up to 4 transmitters/channels. If an attempt is made to program an additional transmitter, the motor will respond by moving, but the transmitter will not be stored.
- * A previously stored transmitter (base transmitter) must be used to program additional transmitters into the memory of the HRC-RF.
- * A minimum of one transmitter will always remain in the memory of the HRC-RF. Pressing the Memory Clear button on the HRC-RF will delete all transmitters from memory.
- * When programming mode is active, the HRC-RF cannot be operated until programming mode is deactivated. Deactivation occurs automatically after a transmitter is programmed or after 30 seconds if a transmitter is not memorized.
- * The HRC-RF will not enter programming mode if tilt mode is activated.

PROGRAMMING A TRANSMITTER INTO MEMORY

- Clear the HRC-RF memory by pressing the Memory Clear button on the control board. The motor will respond by moving the window treatment. Press and release the programming button on the Telis1 or Telis4 transmitter to enter programming mode. The motor will respond by moving the window treatment. Press and release the programming button once more, making sure the desired channel is selected on the Telis4 first. The motor will again respond by moving the treatment. The transmitter is now stored into memory.

ADDING ADDITIONAL TRANSMITTERS INTO MEMORY

- Press and release the programming button on a transmitter that is already memorized by the HRC-RF to enter programming mode. The motor will briefly move UP and DOWN. Press and release the programming button on the new transmitter (For Telis4, ensure desired channel is selected first), the motor will again move UP and DOWN. The transmitter is now memorized.

DELETING A TRANSMITTER FROM MEMORY

- Press and release the programming button on a transmitter (other than the one to be deleted) already memorized by the HRC-RF. The motor will briefly move UP and DOWN. Press and release the programming button on the transmitter to be deleted, the motor will begin to move. That transmitter will no longer activate the HRC-RF.

WIRING DIAGRAM

CAUTION: Before proceeding with the line voltage wiring instructions, the up and down limits of each motor should be set using the SOMFY tester cable (Cat. No. 6020086). Refer to the limit switch instructions packaged with each SOMFY motor for more information.

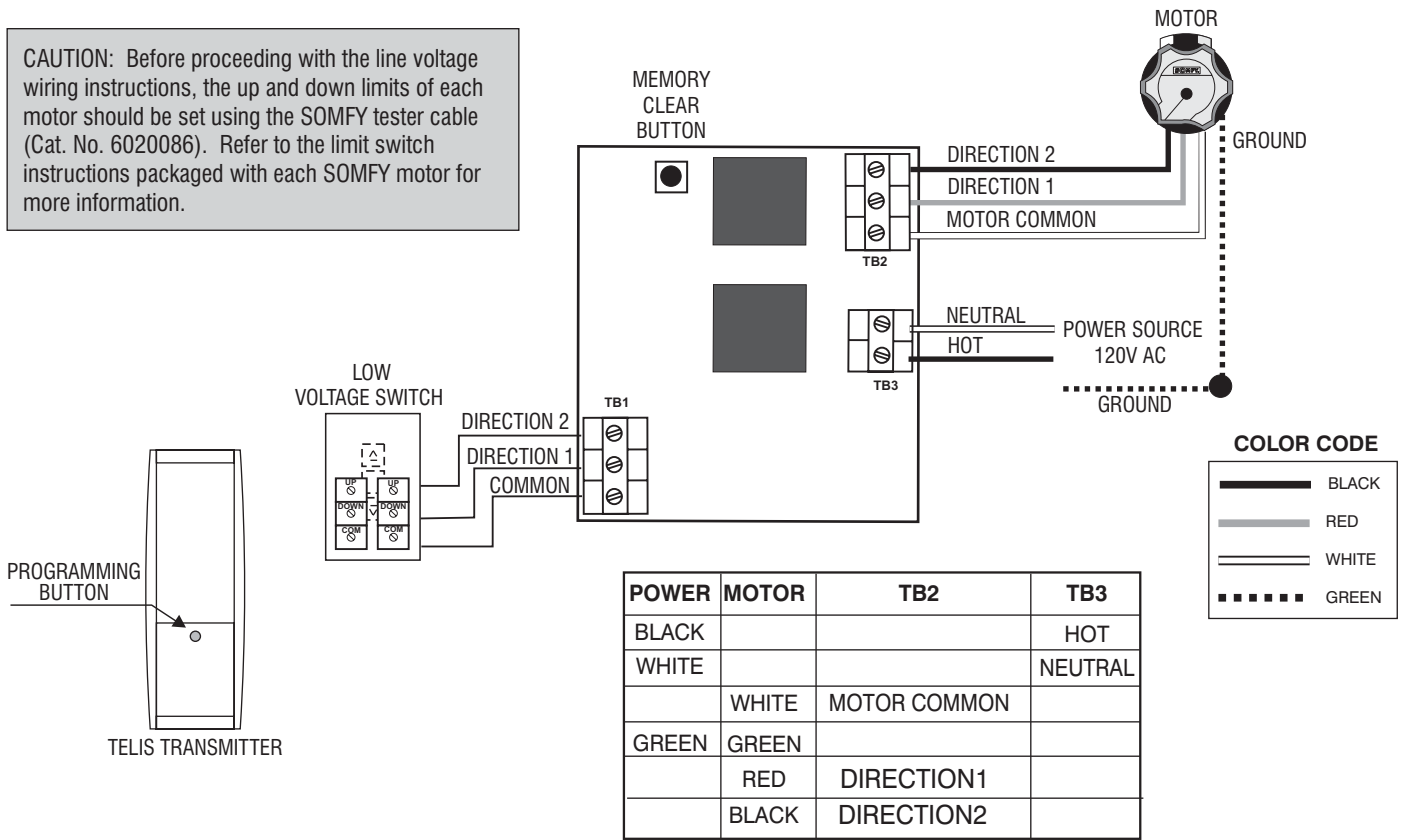

HOME AUTOMATION INTERFACE

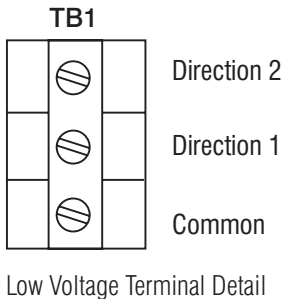

Low voltage terminals are provided on the HRC-IR for interfacing to home automation or other third party systems. To activate an Up command, a momentary dry contact (relay) closure is required between the DIRECTION 1 input and COMMON. This contact should remain closed less than 0.5 seconds for lift, or greater than 0.5 seconds for tilt. Similarly, to activate a Down command, a contact closure is required between the DIRECTION 2 and COMMON terminals.

If the window treatment is in motion, a Stop command is given by activating the direction of movement. For example, if the treatment is moving up, activating another UP command within 3 minutes will stop the window treatment. Alternately, to activate a STOP command, a contact closure is required between DIRECTION 1, DIRECTION 2 and COMMON terminals.

ORDERING INFORMATION

Description	Catalog Number
HRC-RF	6300982
Single IGC Switch	6300040 (White), 6300140 (Ivory)
Telis Transmitter	6301014
Telis4 Transmitter	6301015
Decorator RTS Switch	6301033 (White), 6301034 (Ivory)
Decorator RTS Switch (4 Channel)	6301025 (White), 6301035 (Ivory)
Chronis RTS Timer	6300383



Cat. No. 6300040



Cat. No. 6301015

MULTI-CHANNEL INFRARED CONTROL (MCIR)

DESCRIPTION

The Multi-Channel Infrared Control (MCIR) is a single motor controller with an addressable infrared remote input. Up to 15 unique addresses may be specified. Optional control methods include a low voltage switch and radio remote control. Input terminals for both are provided.

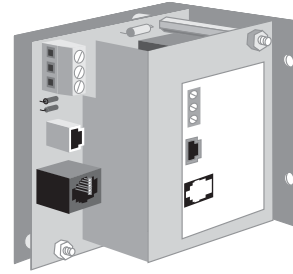

MECHANICAL SPECIFICATIONS

Overall Dimensions: L: 3 1/2 in. W: 3 3/8 in. D: 1 3/4 in.

Typical Range (Optimal Conditions): Radio Remote: 75 ft. Infrared Remote: 20 ft.

Maximum Controls connected to a single IR sensor is 10

Installs in a standard 2 gang masonry electrical box

ELECTRICAL SPECIFICATIONS

Voltage Ratings: INPUT: 115 VAC +/- 10% 50/60 Hz
OUTPUT: 115 VAC 5A 1/4 HP
Fuse 5A

Approvals: Complies with the National Electrical Code Standards (NEC).
UR, cUR approved

ORDERING INFORMATION

Description	Catalog Number
MCIR - (115 VAC)	6300885
MCIR - (220 VAC)	6300985
Single IGC Switch	6300040 (White), 6300140 (Ivory)
Radio Receiver/Transmitter Kit	6300447
Infrared Sensor	6300866
Single Channel Transmitter	6300879
Eight Channel Transmitter	6300988
15 Channel Transmitter	6300500
2 Gang Electrical Box	5670323



Cat. No. 6300040



Cat. No. 6300988

MCIR WIRING SCHEMATIC

CAUTION: Before proceeding with the line voltage wiring instructions, the up and down limits of each motor should be set using the SOMFY tester cable (Cat. No. 6020086). Refer to limit switch instructions packaged with each SOMFY motor for more information.

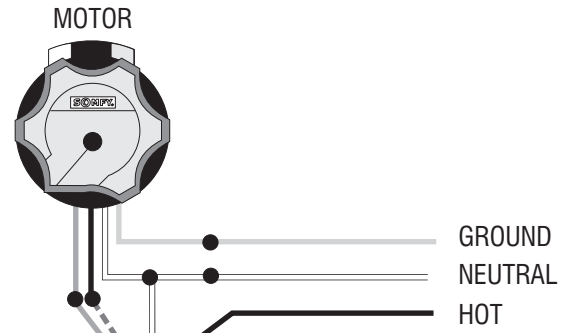

COLOR CODE

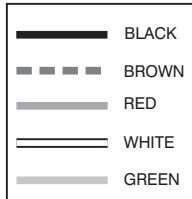

OPTIONAL LOW VOLTAGE SWITCH

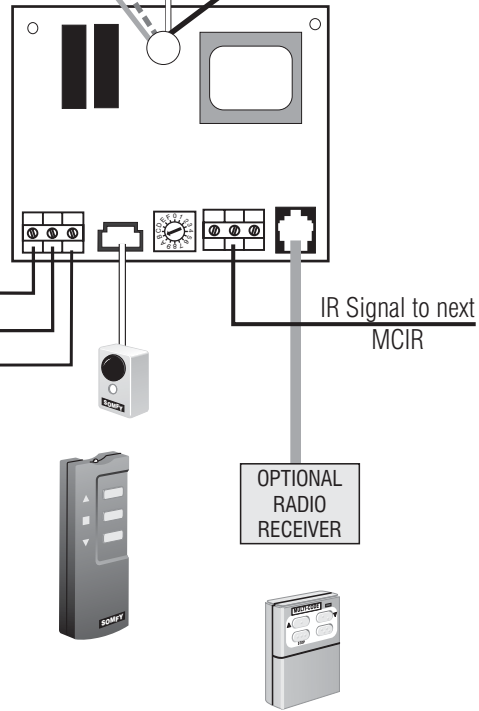
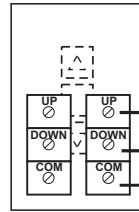

LOW VOLTAGE TERMINALS DETAIL

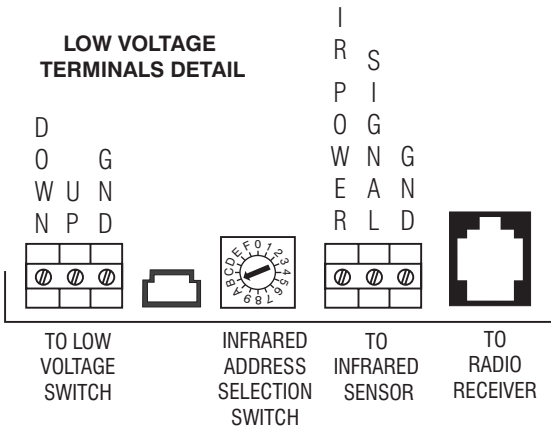

HOME AUTOMATION INTERFACE

LOW VOLTAGE TERMINALS DETAIL

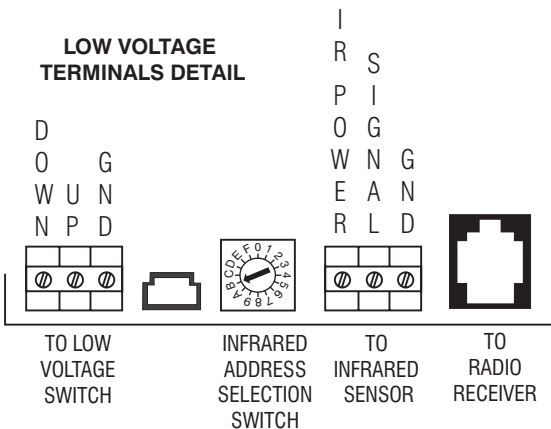

Low voltage terminals are provided on the MCIR for interfacing to home automation or other third party systems. To activate an Up command, a momentary dry contact (relay) closure is required between the UP input and COMMON. This contact should remain closed at least 0.5 seconds. Similarly, to activate a Down command, a contact closure is required between the DOWN and COMMON terminals.

If the window treatment is in motion, a Stop command is given by activating the direction of movement. For example, if the treatment is moving up, activating another UP command within 3 minutes will stop the window treatment. Alternately, to activate a STOP command, a contact closure is required between the UP, DOWN and COMMON terminals.

HEADRAIL CONTROL - IR (HRC-IR)

DESCRIPTION



SOMFY'S Headrail Infrared Remote Control is specially designed to mount inside an industry standard 2"x2" headrail. It is capable of both lift and tilt functions for a variety of interior window treatment applications. Remote control is possible through the use of SOMFY's single, eight or 15 channel infrared transmitters. In addition, a low voltage switch can be connected that will control the window treatment with a push of a button.

MECHANICAL SPECIFICATIONS

Overall Dimensions: L: 3 1/6 in. W: 2 1/6 in. D: 1 2/5 in.

Typical Range (Optimal Conditions): 20 ft.

Maximum HRC-IRs connected to one IR sensor: 10

ELECTRICAL SPECIFICATIONS

Voltage Ratings: INPUT: 115 VAC +/- 10% 50/60 Hz
OUTPUT: 115 VAC 5A 1/4 HP

Approvals: Complies with the National Electrical Code Standards (NEC).
UR, cUR approved

ORDERING INFORMATION

Description	Catalog Number
HRC-IR	6300983
HRC-IR (15 Channel)	6300783
Single IGC Switch	6300040 (White), 6300140 (Ivory)
Infrared Sensor	6300866
Single Channel Transmitter	6300879
Eight Channel Transmitter	6300988
15 Channel Transmitter	6300500

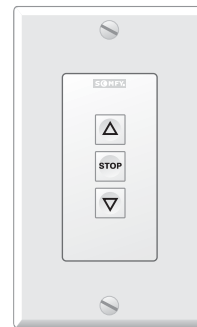

Cat. No. 6300040



Cat. No. 6300988

HRC-IR WIRING SCHEMATIC

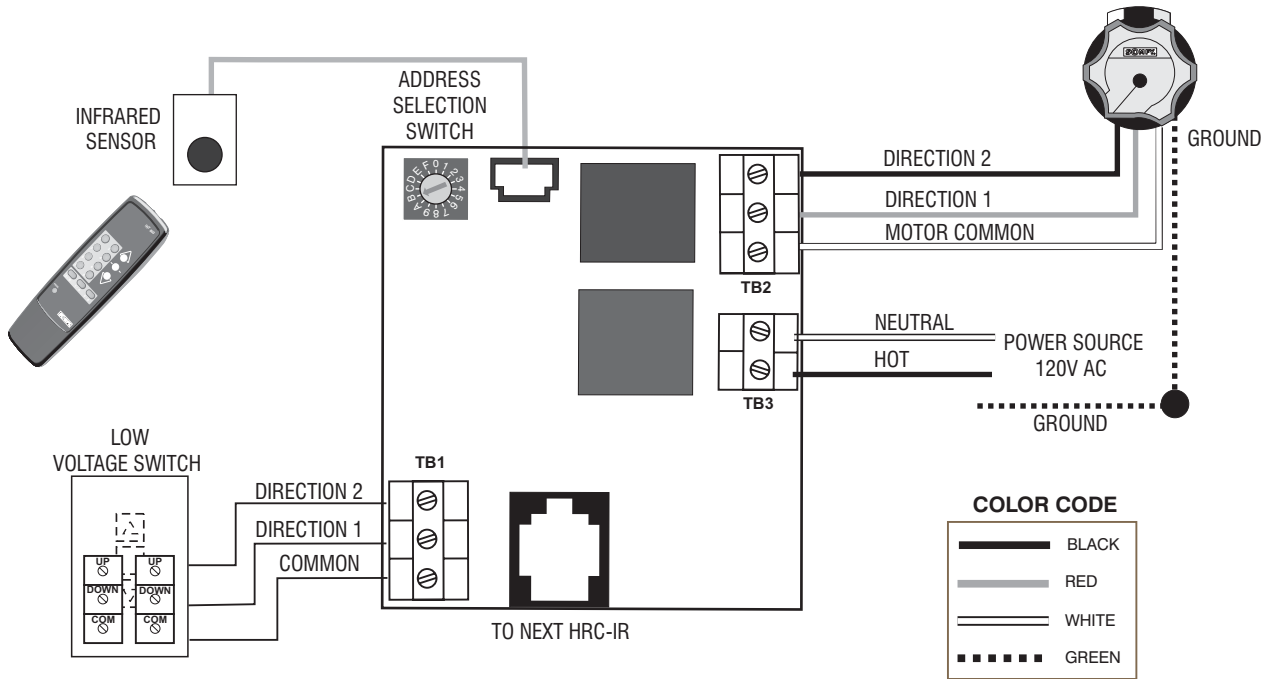

POWER	MOTOR	TB2	TB3
BLACK			HOT
WHITE			NEUTRAL
	WHITE	MOTOR COMMON	
GREEN	GREEN		
	RED	DIRECTION1	
	BLACK	DIRECTION2	

CAUTION: Before proceeding with the line voltage wiring instructions, the up and down limits of each motor should be set using the SOMFY tester cable (Cat. No. 6020086). Refer to the limit switch instructions packaged with each SOMFY motor for more information.

HOME AUTOMATION INTERFACE

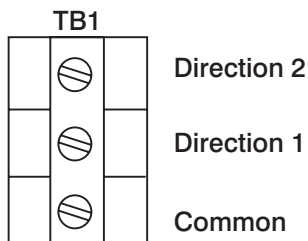

Low Voltage Terminal Detail

Low voltage terminals are provided on the HRC-IR for interfacing to home automation or other third party systems. To activate an Up command, a momentary dry contact (relay) closure is required between the DIRECTION1 input and COMMON. This contact should remain closed less than 0.5 seconds for lift, or greater than 0.5 seconds for tilt. Similarly, to activate a Down command, a contact closure is required between the DIRECTION2 and COMMON terminals.

If the window treatment is in motion, a Stop command is given by activating the direction of movement. For example, if the treatment is moving up, activating another UP command within 3 minutes will stop the window treatment. Alternately, to activate a STOP command, a contact closure is required between the DIRECTION1, DIRECTION2 and COMMON terminals.

IRS 300

INFRARED CONTROL FOR DC MOTORS

DESCRIPTION

The IRS 300 provides infrared control for SOMFY's Concept 25 and LT28 motors. It is an addressable, multichannel receiver/control with lift and tilt capabilities. In addition, the IRS 300 provides inputs for both individual and master switches. Each individual IRS 300 can operate up to 3 motors as a group, depending on transformer rating.



MECHANICAL SPECIFICATIONS

Overall Dimensions: L: 2 in. W: 3 in. D: 1 1/4 in.

Typical Range (Optimal Conditions): 20 ft.

ELECTRICAL SPECIFICATIONS

Voltage Rating: INPUT: 24 VDC
OUTPUT: 24 VDC, 750mA per motor

Approvals: Complies with the National Electrical Code (NEC) Standard
CE approved

RECOMMENDED TRANSFORMERS

MOTOR TYPE	1 MOTOR	2 MOTOR	3 MOTOR
LT28A	5700088	5700091	5700091
LT28B	5700095	5700093	5700093
LV25-B44	5700095	5700093	5700096
LV25-B64	5700095	5700093	5700096
LW25-B83	5700093	5700096	5700096
LT28-H2	5700093	5700096	5700098

TYPICAL APPLICATION

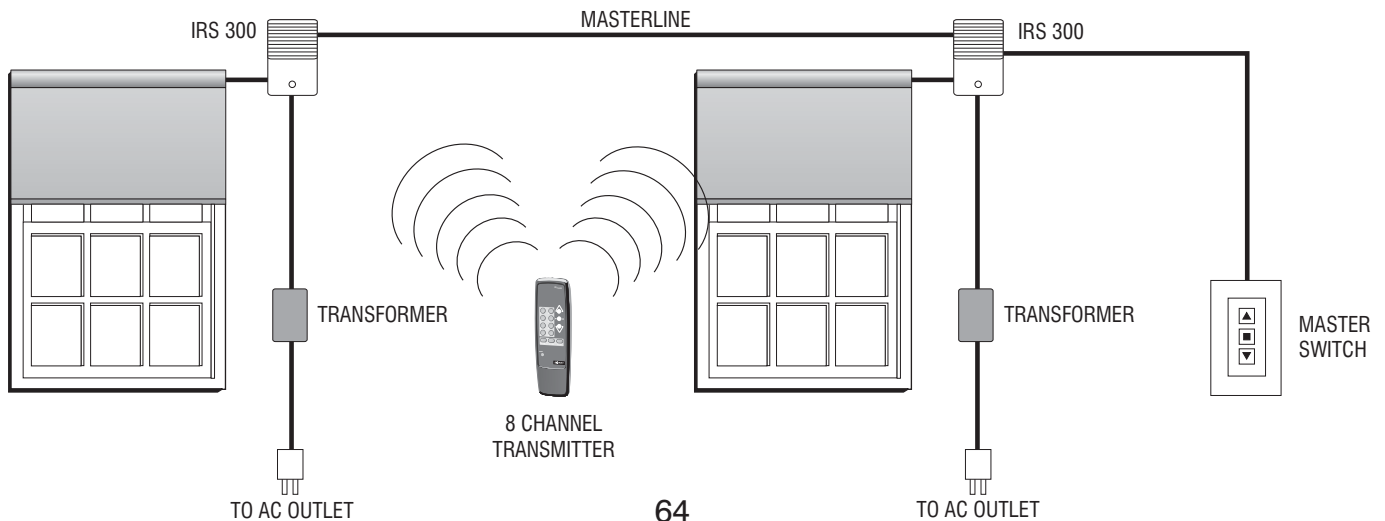

HOME AUTOMATION INTERFACE

The screw terminals on the IRS 300 can be used for interfacing to home automation or other third party systems. To activate a Master Up command, a momentary dry contact (relay) closure is required between the Master Up (▲) input and Common (C). This contact should remain closed for less than 0.5 seconds to raise or lower a shade, or more than 0.5 seconds to tilt a horizontal blind. Similarly, to activate a Master Down command, a contact closure is required between the Master Down (▼) and Common terminals. To activate a STOP command, a contact closure is required between the Master Up, Master Down and Common terminals.

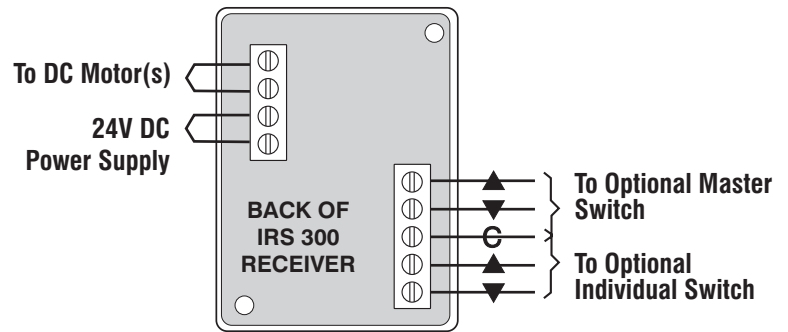

Follow the above timing requirements for the individual input.

PROGRAMMING INSTRUCTIONS

For greater details, please refer to product instructions

SETTING INDIVIDUAL ADDRESSES

- Press and hold the PROGRAM button on the IRT803 Transmitter for at least 5 seconds to enter programming mode. The window covering will respond by moving briefly.
- Press the “1” button on the transmitter, the motor will stop moving. Press the numeric key corresponding to the desired individual address, the control will respond by briefly moving the window covering.
- Proceed with another setting or press the PROGRAM button to exit.

SETTING THE TILT SPEED

- If not already in programming mode, enter programming mode as described above.
- Press the “5” button on the transmitter, the motorized blind will begin to tilt.
- Increase the speed by pressing the UP button on the transmitter, or decrease the speed by pressing the DOWN button.
- Press the “5-8” button on the transmitter to confirm tilt setting, the window covering will begin to move briefly.
- Proceed with another setting or exit programming mode

CANCELLING THE TILT FUNCTION

- Enter programming mode, if not already. Press the “2” key, then the “1” key on the transmitter.
- Press the PROGRAM button to exit.

ORDERING INFORMATION

Description	Catalog Number	Description	Catalog Number
IIRS 300	6300989	Transformers	
Transmitters		24 VDC, 600mA	5700095
Single Channel Transmitter	6300879	24 VDC, 1A	5700093
8 Channel Transmitter	6300988	24 VDC, 1.2A	5700193
Transformers		24 VDC, 2.5A	5700096
12 VDC, 1A	5700088	24 VDC, 6.5A	5700098
12 VDC, 3A	5700091	Switches	
12 VDC, 5A	5700092	Single IGC Switch - White	6300040
		Single IGC Switch - Ivory	6300140

WIRELESS COMMAND II

DESCRIPTION

SOMFY's Wireless Command II features both the ease of plug-in installation plus the convenience of radio remote control. This single motor control unit with an integrated radio receiver plugs into any AC outlet. Your SOMFY motor plugs directly into the Wireless Command. A single channel remote provides sequential control for one motor.

Also available in two, three and four motor versions, the Wireless Command kits feature two or four (3 and 4 motor kits) channel radio transmitters for individual control.



NOTE: Power plug installed on motor must be ordered separately. Cat. No. 6180196

MECHANICAL SPECIFICATIONS

Overall Dimensions: L: 2 1/2 in. H: 4 3/4 in. D: 2 1/2 in.

Typical Range (Optimal Conditions): 75 ft.

ELECTRICAL SPECIFICATIONS

Voltage Ratings: INPUT: 115 VAC +/- 10% 50/60 Hz

OUTPUT: 115 VAC 5A 1/4 HP

Approvals:

Complies with the National Electrical Code Standards (NEC)
UR, cUR and FCC approved

INSTALLATION NOTES

Make sure the SOMFY motor upper and lower limits are properly adjusted before installing the Wireless Command. Refer to the limit switch instruction sheet enclosed with the motor for further information. SOMFY SYSTEMS recommends the use of a motor tester cable. (Cat. No. 6180140)

NOTE: To reduce the risk of electric shock, this equipment has a grounding type plug with a third (grounding) pin. This plug will only fit into a grounding type outlet. If the plug does not fit into the outlet, contact a qualified electrician to install the proper outlet. DO NOT change the plug in any way.

A single motor can be controlled from the radio transmitter or the push button located on the bottom of the control. Each press of the switch will sequence through the directions as follows:

DEPRESS 1 UP DIRECTION
DEPRESS 2 STOP
DEPRESS 3 DOWN DIRECTION
DEPRESS 4 STOP

When the motorized system reaches its upper or lower limit, the Wireless Command automatically resets the system to reverse directions the next time the switch is pressed.

SYSTEM VARIATIONS

Single Motor Control

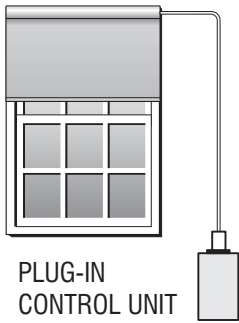

PLUG-IN
CONTROL UNIT



SINGLE BUTTON
TRANSMITTER

Multi-Motor Control

SOMFY's Wireless Command can be configured to allow individual control of up to four motors. For multi-motor operation, the controls should be placed at least 5 feet apart. A 2 channel transmitter can operate 2 motors, while a 4 channel transmitter will operate up to four.

Double Motor Control

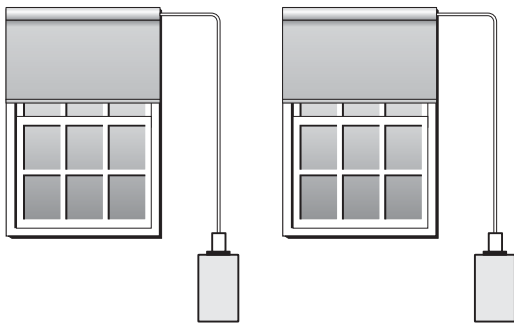

DUAL BUTTON
TRANSMITTER

Three and Four Motor Control

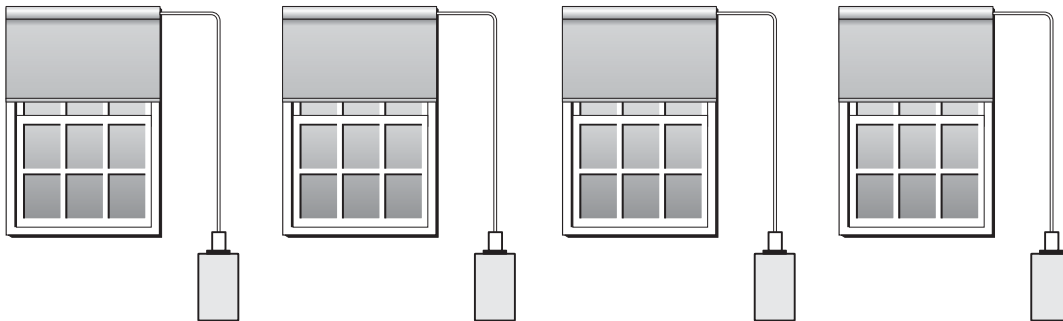

Four Button
Transmitter
(for 3 and 4
channel kits)

ORDERING INFORMATION

Description

Wireless Command (Control only)
 Single Channel Wireless Kit (Control & Transmitter)
 Two Channel Wireless Kit (2 Controls & 2 Chan. Transmitter)
 Three Channel Wireless Kit (3 Controls & 4 Chan. Transmitter)
 Four Channel Wireless Kit (4 Controls & 4 Chan. Transmitter)
 Single Channel Transmitter
 Two Channel Transmitter
 Three/Four Channel Transmitter
 Power Plug Installed on Motor (extensions available)
 Unassembled Power Plug Kit

Catalog Number

6300648
 6300313
 6300458
 6300582
 6300469
 6300508
 6300507
 6300509
 6180196
 6020356

SINGLE MOTOR REMOTE

DESCRIPTION

SOMFY's Remote Control line provides motor control from a distance through the use of a hand held radio transmitter. For convenience, kits of up to four Single Motor Remotes are available with individual control of all motors from a single transmitter.

The Single Motor Remote Control features normally-closed input terminals, to be used when starting a motor would cause damage to an open door or window. This input would interface with a window alarm contact and disable the control when the window or door is open.

The Remote Control also has dry-contact output capability. This enables the control to operate other devices, such as SOMFY's GCS-II.



MECHANICAL SPECIFICATIONS

Overall Dimensions: Remote: L: 3 1/2 in. W: 3 1/4 in. D: 2 1/4 in.
Receiver: L: 3 in. W: 4 3/4 in. D: 1 3/8 in.

Typical Range (Optimal Conditions): 75 ft.

Remote Control fits in a standard 2 gang masonry electrical box

ELECTRICAL SPECIFICATIONS

Voltage Ratings:

INPUT:	120 VAC +/- 10%	50/60 Hz	
OUTPUT:	120 VAC	5A	1/4 HP
	Fuse	5A	115/230 VAC

Approvals: Complies with the National Electrical Code (NEC) Standard, UR, CSA, and FCC.

APPLICATIONS

A . Single Motor Remote Control

A single motor can be controlled from a remote switch or radio transmitter. Each press of the switch will sequence through the directions as follows;

- DEPRESS 1 UP DIRECTION
- DEPRESS 2 STOP
- DEPRESS 3 DOWN DIRECTION
- DEPRESS 4 STOP

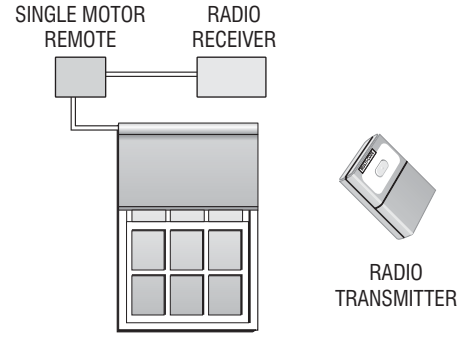

B. Multiple Motor Remote Control

SOMFY's Single Motor Remote Control is prepackaged in kits for 2, 3, and 4 motor operation from a single transmitter. A 2 channel transmitter operates two motors, while the 4 channel transmitter operates up to four. Receivers should be mounted at least 10 feet apart.

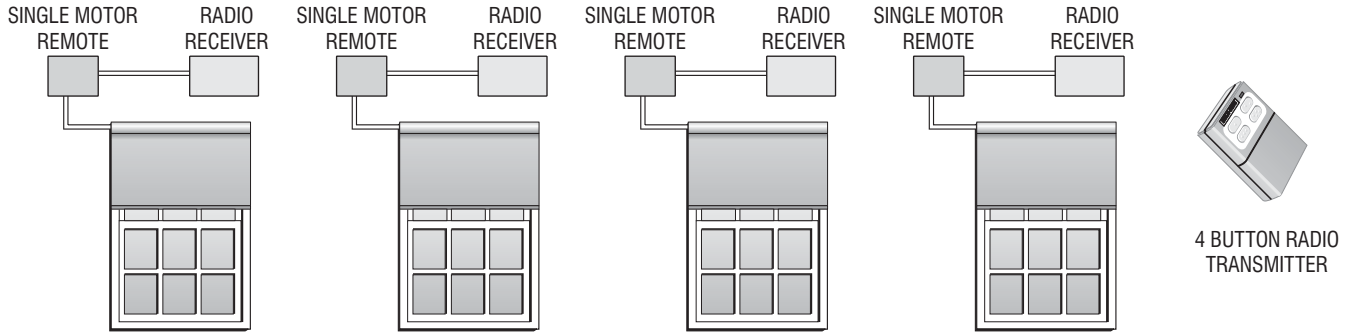

C. Group Control

SOMFY's Group Control System (GCS-II) can be controlled by radio remote by connecting the Single Motor Remote Control to the Low Voltage Switch Connector on the GCS-II. This will provide group only remote control of up to four motors.

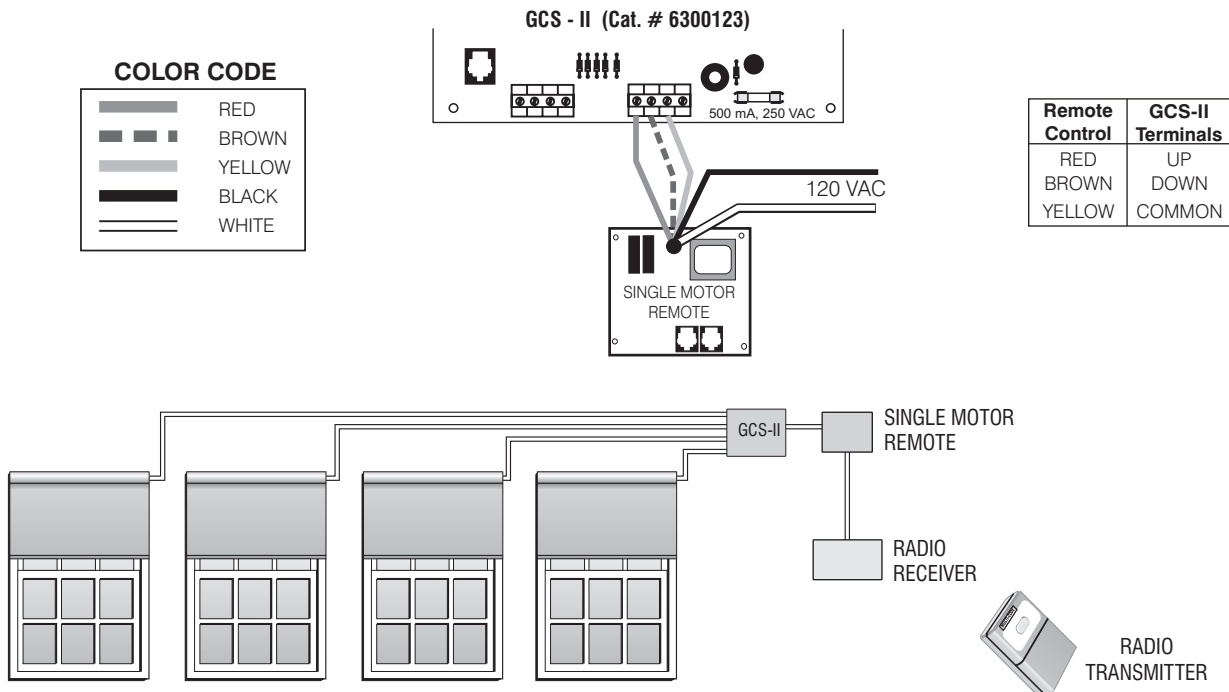

HOME AUTOMATION INTERFACE

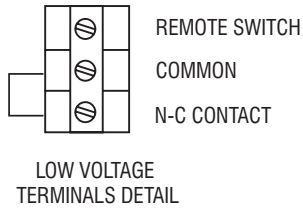

Low voltage terminals are provided for interfacing to home automation or other third party systems. A momentary dry contact (relay) closure is required between the REMOTE SWITCH input and COMMON. This contact should remain closed at least 0.5 seconds, but no more than 1 second. Each closure will sequence through the commands as follows: UP, STOP, DOWN, STOP.

WIRING SCHEMATIC

COLOR CODE

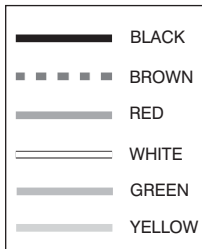

CAUTION: Before proceeding with the line voltage wiring instructions, the up and down limits of each motor should be set using the SOMFY tester cable (Cat. No. 6020086). Refer to the limit switch instructions packaged with each SOMFY motor for more information.

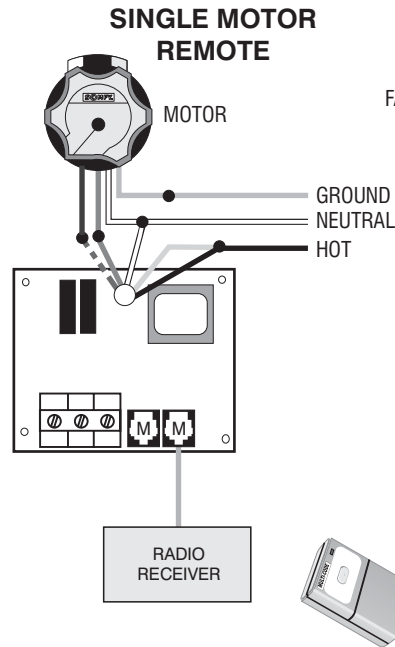

LOW VOLTAGE TERMINAL DETAIL

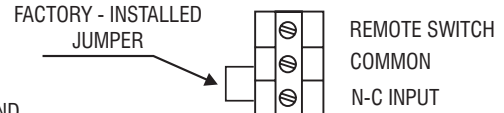

A single-pole, single-throw momentary switch can be connected between the SWITCH and COMMON terminals.

The N-C (normally closed) INPUT terminal is for a normally closed contact connected to a casement window or french door. When the door or window opens, this contact opens and disables the down direction. **DO NOT REMOVE** FACTORY INSTALLED JUMPER IF THIS FEATURE IS NOT UTILIZED.

ORDERING INFORMATION

Description

Catalog Number

Description

Catalog Number

Standard Remote Control

Remote Controller 115 VAC (Control Only)	6300690
Single Motor Remote Control Kit (Control, Receiver, Transmitter)	6300696
Two Motor Remote Control Kit	6300697
Three Motor Remote Control Kit	6300698
Four Motor Remote Control Kit	6300699
Remote Controller (230 VAC)	6300681
Single Motor Remote Control Kit (230 VAC)	6300680

Receivers/Transmitters

Plug-in Single Channel Radio Receiver	6300703
Single Channel Transmitter	6300508
Two Channel Transmitter	6300507
Three/Four Channel Transmitter	6300509

Accessories

Indoor Digital Keypad	6300739
Outdoor Digital Keypad	6300740
SPST Momentary Switch	6300080
Momentary Outdoor Key Switch (FM, SM)	6120622, 6120212
2 Gang Electrical Box	5670323

3N1 REMOTE CONTROL

DESCRIPTION

SOMFY's 3N1 Remote Control provides motor control from a distance through the use of a hand held radio transmitter. It is available for those installations requiring control of three motors both individually and as a group.

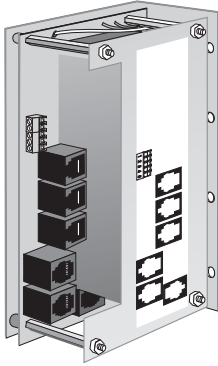

MECHANICAL SPECIFICATIONS

Overall Dimensions: 3N1 Remote: L: 7 ¹/₄ in. W: 3 ¹/₂ in. D: 1 ⁷/₈ in.
Receiver: L: 6 ³/₄ in. W: 4 ³/₄ in. D: 1 ¹/₂ in.

Typical Range (Optimal Conditions): 75 ft.

3N1 Remote fits in a standard 4 gang masonry electrical box

ELECTRICAL SPECIFICATIONS

Voltage Ratings:

INPUT: 120 VAC +/- 10% 50/60 Hz

OUTPUT: 120 VAC 15A (5A per motor) 1/4 HP
Fuses 3 x 5A

Approvals: Complies with the National Electrical Code (NEC) Standard, UR, CSA, and FCC.

ORDERING INFORMATION

Description	Catalog Number	Description	Catalog Number
3N1 Remote Control	6300822	Receivers/Transmitters	
3N1 Remote Control Kit		3N1 Remote Radio Receiver	6300825
(Control, Receiver, Transmitter)	6300824	3N1 Receiver/Transmitter Kit	6300826
3N1 Remote Control - 220 VAC	6300828	4 Channel Transmitter	6300510
3N1 Remote Control Kit - 220 VAC	6300831	Accessories	
		SPST Momentary Switch	6300080
		4 Gang Electrical Box	5670064

INDIVIDUAL-GROUP CONTROL

With SOMFY's 3N1 Remote Control, up to 3 motors can be operated both individually and as a group from a single transmitter.

- BUTTON 1... Motor 1
- BUTTON 2... Motor 2
- BUTTON 3... Motor 3
- BUTTON 4... All Motors

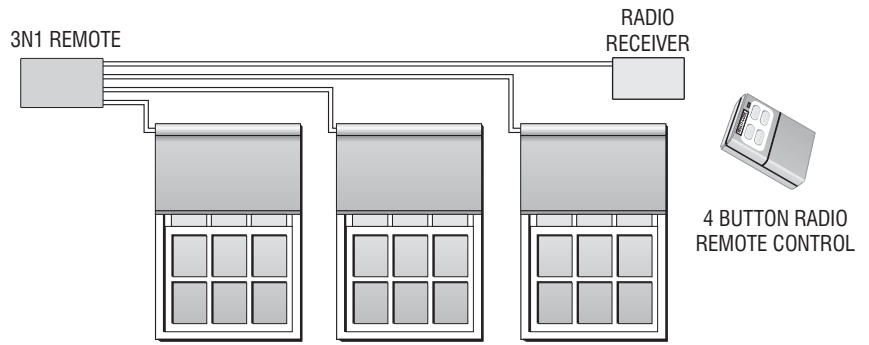

WIRING DIAGRAM

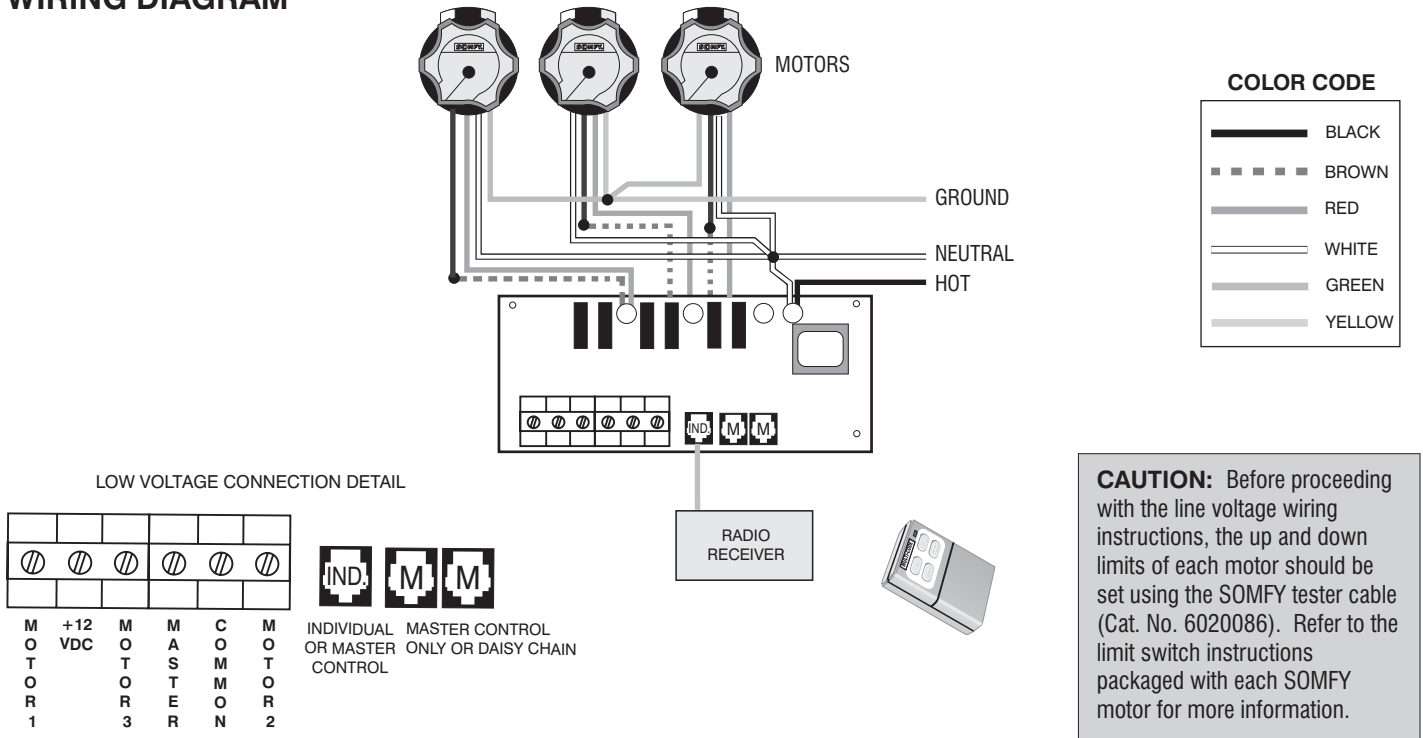

LOW VOLTAGE CONNECTION DETAIL

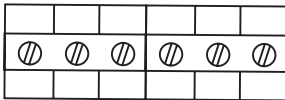

M	+12	M	M	C	M
O	VDC	O	A	O	O
T		T	S	M	T
O		O	T	O	O
R		R	E	R	R
1		3	R	N	2



INDIVIDUAL MASTER CONTROL
OR MASTER ONLY OR DAISY CHAIN
CONTROL



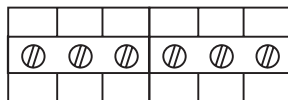







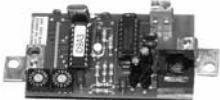
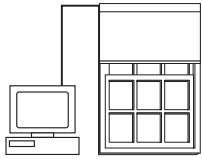

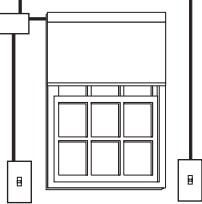
HOME AUTOMATION INTERFACE

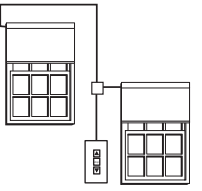

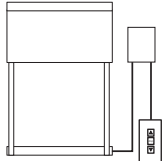
MOTOR 1
+12 VDC
MOTOR 3
MASTER
COMMON
MOTOR 2

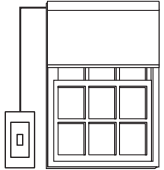
Low voltage terminals are provided for interfacing to home automation or other third party systems. A momentary contact (relay) closure is required between the motor input and common. For example, to activate Motor1, a contact closure is required between the MOTOR1 and COMMON terminals. This contact closure should be at least 0.5 seconds, but no more than one second. Each contact closure will sequence through UP, STOP, DOWN, STOP for each motor input.

A contact closure between the MASTER terminal and COMMON will activate all the motors on the 3N1 Remote Control.

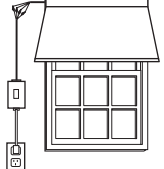
	<p><i>RS 232</i></p>	<p>74</p>	
	<p><i>MultiSwitch Command</i></p>	<p>75</p>	
	<p><i>Synchronization Control</i></p>	<p>76</p>	
	<p><i>Fabric Tension System</i></p>	<p>78</p>	
	<p><i>LT28 Stall Sensor</i></p>	<p>79</p>	
	<p><i>ILT Controls</i> <i>LON Controls</i></p>	<p>80 82</p>	
	<p><i>Accessories</i></p>	<p>84</p>	

RS232 INTERFACE MODULE

DESCRIPTION

The SOMFY RS232 Interface Module translates RS232 protocol for use with SOMFY controls. This unit can connect to any PC, home automation or lighting system. Each addressable device connects to one SOMFY control such as an IGC or MCIR. One RS232 module is required for each motor or group. The RS232 Interface makes it simple to control window coverings by computer.

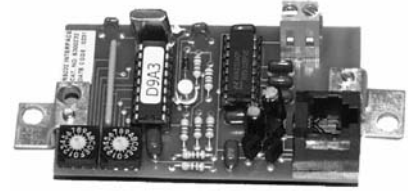

Catalog No. 6300232

MECHANICAL SPECIFICATIONS

Overall Dimensions: L: 1 $\frac{3}{4}$ in. W: 3 in.

Mounts in a standard single gang box

ELECTRICAL SPECIFICATIONS

Input Voltage: 12V DC, 150mA (supplied by IGC or MCIR)

Output Voltage: 12V DC, 150mA, open collector

OPERATING SPECIFICATIONS

The RS232 Interface Module receives and translates UP, STOP and DOWN commands. The interface uses the following communication settings.

Settings:
9600 Baud
8 Data Bits
1 Stop Bit
No Parity

The SOMFY protocol is available upon request.

APPLICATION

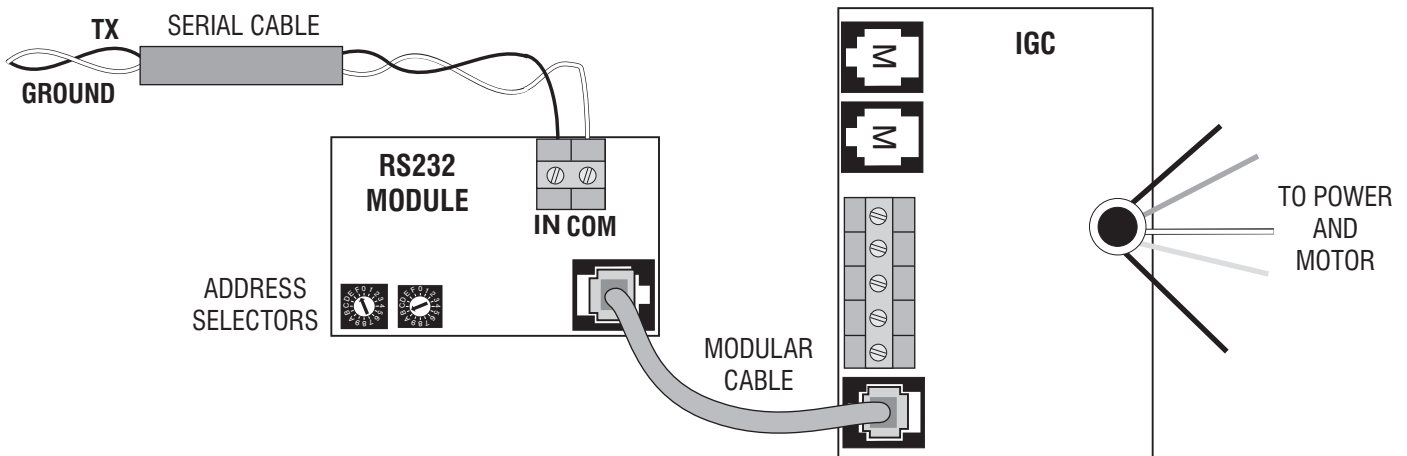

MULTI-SWITCH COMMAND

DESCRIPTION

The Multi-Switch Command offers the convenience of controlling one operator, by more than one switch, from one or more locations. It correctly isolates different switches controlling the same motor. This protects the motor from receiving opposite commands at the same time. The Multi-Switch Command is activated by standard UP/DOWN momentary switches. It mounts in a standard single gang electrical box.

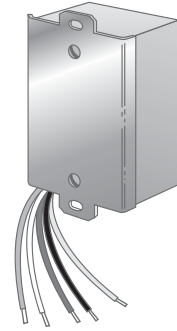

Catalog No. 6300427

APPLICATION

Correct

One Motor, 2 Switches

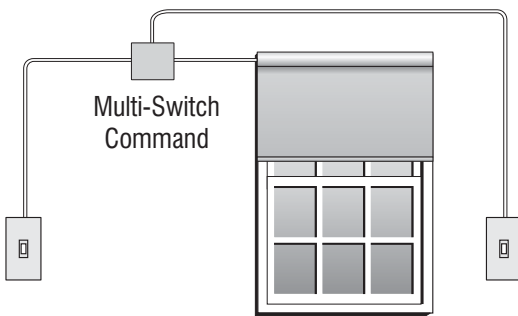

Incorrect

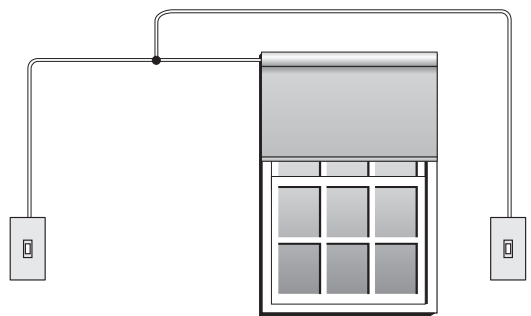

WIRING DIAGRAM

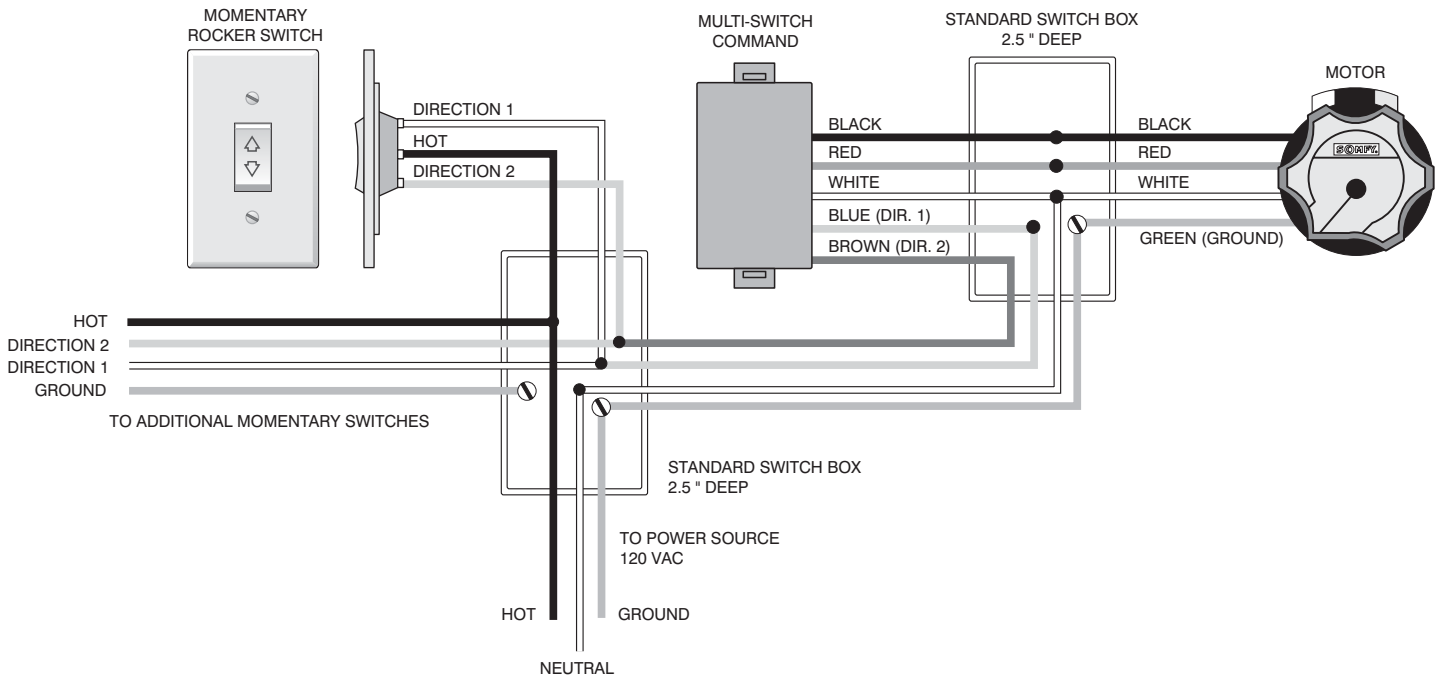

SYNCHRONIZING CONTROL

DESCRIPTION

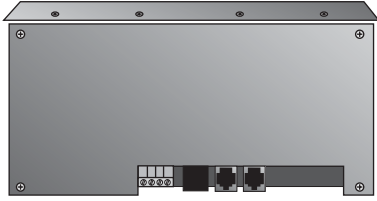

SOMFY'S Synchronizing Control is designed to control two motors simultaneously. When two SOMFY motors are mounted in a single tube, moving a single window covering, it is important that the motors coincide with each other. The Synchronizing Control actuates and stops both motors at the same time. This helps prevent damage to the tube, motor, and window covering. It is very important not to exceed the load/weight limitations of the mounting hardware such as brackets, fasteners, etc. when synchronizing two SOMFY operators. The Synchronizing Control is available with either maintained (IGC-type) or momentary (GCS-type) outputs.

MECHANICAL SPECIFICATIONS

Overall Dimensions: L: 7 1/4 in. W: 3 1/2 in. D: 1 7/8 in.

Maximum lifting capacity of the Synchronizing system is 300lbs.

Installs in a standard 4 gang masonry electrical box.

ELECTRICAL SPECIFICATIONS

Voltage Ratings:

INPUT: 120VAC +/- 10% 50/60 Hz

OUTPUT: 120VAC 10A (5A/ motor) 1/4 HP
Fuses 3 x 5A

Approvals: Complies with the National Electrical Code (NEC) standard.
UR and cUR approved

ORDERING INFORMATION

Description	Catalog Number
Synchronizing Control (Maintained Output)	6300889
Synchronizing Control (Momentary Output)	6300886
Synchronizing Control - 220V (Maintained Output)	6300989
Synchronizing Control - 220V (Momentary Output)	6300986
Decorator Switch (Modular Plug)	6300908 (White), 6300937 (Ivory)
Decorator Switch (Terminals)	6300040 (White), 6300140 (Ivory)

WIRING DIAGRAM

NOTE: READ INSTRUCTIONS COMPLETELY BEFORE BEGINNING INSTALLATION.

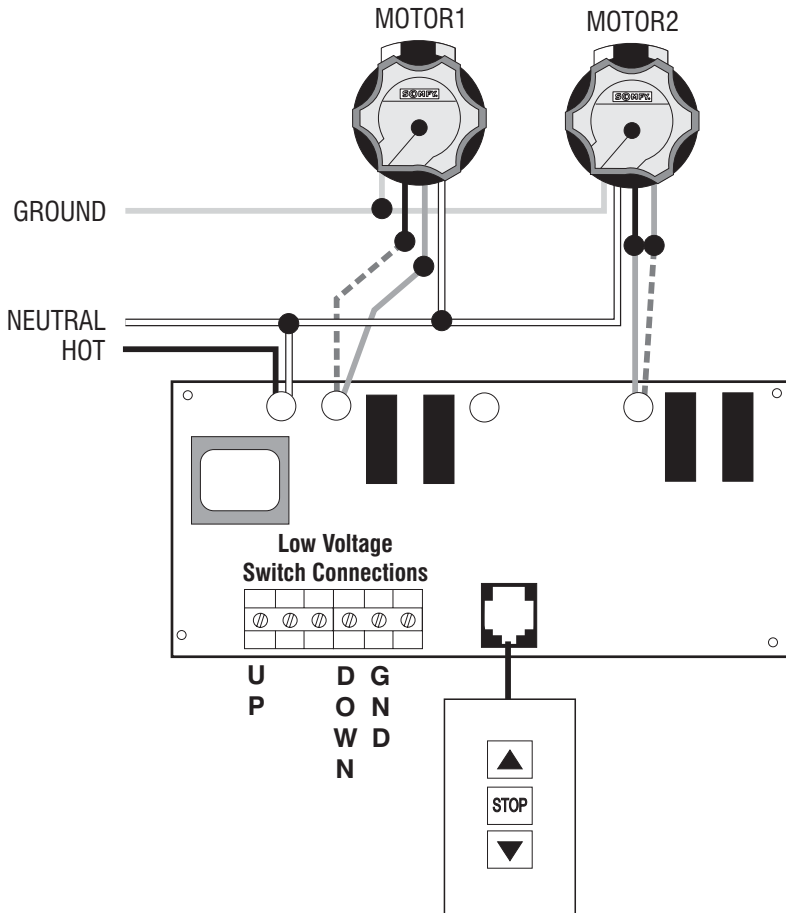

COLOR CODE

	BLACK
	BROWN
	RED
	WHITE
	GREEN

POWER	MOTOR1	MOTOR2	SYNCHRO
BLACK			BLACK
WHITE	WHITE	WHITE	WHITE
GREEN	GREEN	GREEN	GREEN
	RED	BLACK	RED
	BLACK	RED	BROWN

CAUTION: Before proceeding with the line voltage wiring instructions, the up and down limits of each motor should be set using the SOMFY tester cable (Cat. No. 6020086). Refer to the limit switch instructions packaged with each SOMFY motor for more information.

HOME AUTOMATION INTERFACE

Low voltage terminals are provided on the Synchronizing Control for interfacing to home automation or other third party systems.

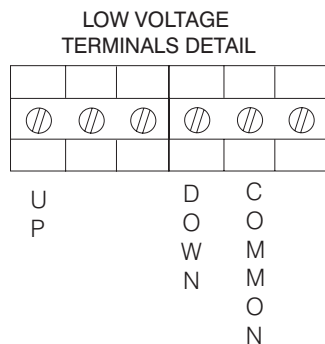

MAINTAINED OUTPUT MODEL:

To activate an UP command, a momentary dry contact (relay) closure is required between the UP input and COMMON. This contact should remain closed at least 0.5 seconds. Similarly, to activate a DOWN command, a contact closure is required between the DOWN and COMMON terminals. To activate a STOP command, a contact closure is required between the UP, DOWN and COMMON terminals.

MOMENTARY OUTPUT MODEL:

To activate an UP command, a maintained dry contact (relay) closure is required between the UP input and COMMON. This contact should remain closed for approximately 3 minutes to ensure full travel of the window covering. Similarly, to activate a DOWN command, a contact closure is required between the DOWN and COMMON terminals. The window covering will stop when the contact closure is released.

FABRIC TENSION SYSTEM CONTROL (FTS)

DESCRIPTION

The FTS is a specialized system designed for the solar protection market where horizontal or inclined type shading is required. The system consists of two specific motors, an electronic control unit and a switch. The control operates each motor independently and maintains a desirable dynamic (moving) tension as well as final tension in the system, eliminating fabric sag while the fabric is both moving and standing. Adjustments to both dynamic and final tension can be made through the electronic control

For more complete information, refer to SOMFY's FTS instructions. SOMFY's motor and control warranties are based on strict adherence to these instructions.



MECHANICAL SPECIFICATIONS

Overall Dimensions: L: 8 in. W: 10 in. D: 4 in.

Operating temperature range: 0° C to 40° C

ELECTRICAL SPECIFICATIONS

Voltage Rating: INPUT: Line Voltage: 115 VAC +/- 10%
Low Voltage: 5 VDC 0.3 A

OUTPUT: 115 VAC 5A (each motor)
Fuse: 10A

Approvals: Complies with the National Electrical Code (NEC) Standard. UL approval pending.

TYPICAL APPLICATION

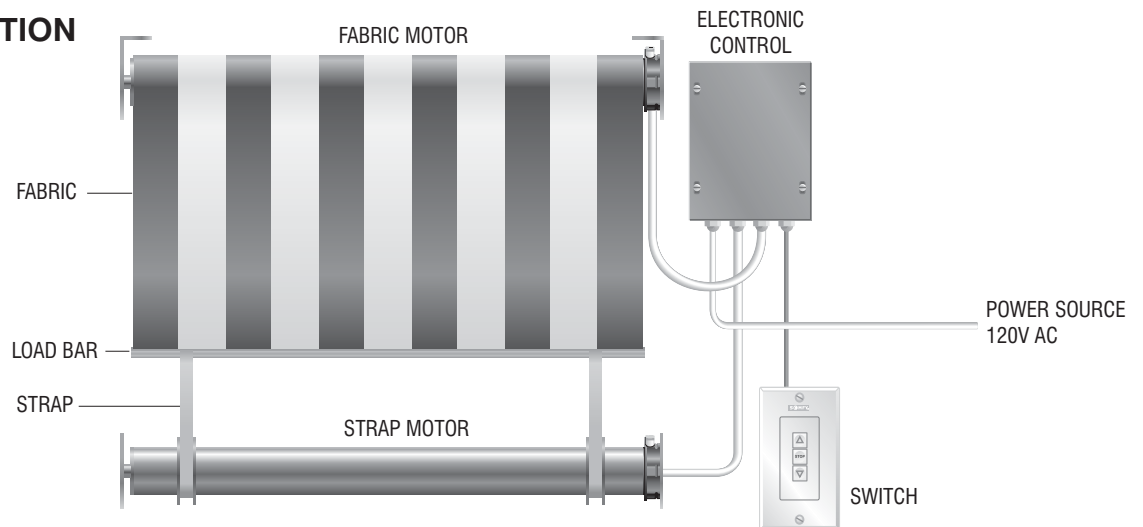

ORDERING INFORMATION

Description	Catalog Number
FTS Control	6300291
Single IGC Switch	6300040 (White), 6300140 (Ivory)
FTS Tester Cable	6020087

LT28 STALL SENSOR

DESCRIPTION

The Stall Sensor is used with interior window coverings that utilize SOMFY's LT28 DC motor. The sensor will cut power to the motor if the bottom of the window treatment meets the headrail before the motor reaches its limit. This prevents stretching of the fabric and extends motor life. This application is useful with certain fabrics that may change shape over time and thus change the actual upper limit. The stall sensor is not intended to replace the upper limit switch of the motor. **NOTE: The LT28 must be modified to work with the Stall Sensor. Please consult the sales staff before ordering.**

The stall sensor is available as a stand-alone unit (shown right) with a designer switch or in an enclosure without a switch. With the enclosed Stall Sensor, a user may connect any low voltage switch to the input terminals.



MECHANICAL SPECIFICATIONS

Overall Dimensions:

Stand Alone Unit: L: 2 ³/₄ in. W: 4 ¹/₂ in. D: 1 ¹/₄ in.

Enclosed Unit: L: 3 ¹/₂ in. W: 2 ¹/₄ in. D: 1 ¹/₂ in.

Stand alone unit installs in a standard single gang box.

ELECTRICAL SPECIFICATIONS

Voltage Ratings: INPUT: 12 VDC 2A
OUTPUT: 12 VDC 750mA

Approvals:

Complies with the National Electrical Code Standards (NEC)

OPERATING PROCEDURES

1. Pressing the switch UP or DOWN will move the motor in the appropriate direction. If the motor does not move in the correct direction, turn off the circuit breakers and reverse the motor wires at the terminal block.
2. When the UP direction is activated the LED on back of the switch will light. This indicates the protected direction. When the window covering reaches the headrail, the sensor will deactivate the motor. The LED will remain lit until either STOP or DOWN is activated.
3. Moving the switch to the center position will stop the motor.
4. FOR ENCLOSED UNIT: Basic operation is the same, however the directional commands will depend on the remote system used.

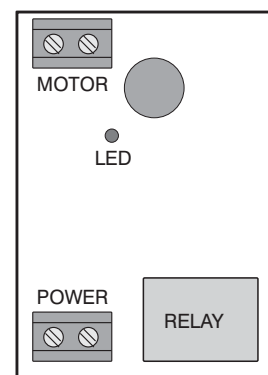

ORDERING INFORMATION

Description

Catalog Number

Decorator Stall Sensor
Stall Sensor w/Enclosure

6300907
6300120

ILT MOTOR CONTROLS

DESCRIPTION

SOMFY's line of ILT motor controls are specifically designed to operate SOMFY's intelligent motors. These controls allow for individual, group or infrared control of one or more ILT motors. Since the ILT motor has on-board intelligence, control interfacing is all done via low voltage wiring. This allows for easy installation and reconfiguration.

COMPONENTS

ILT SWITCH

This decorator, low voltage switch connects directly to the ILT motor using 4 conductor modular cable. The ILT switch can be used to set the motor limits and raise or lower the window covering. The STOP button can be used to set an intermediate position, if desired.



Mechanical Specifications: Overall Dimensions: L: 4 1/2 in. W: 2 3/4 in. D: 1 1/4 in.
Installs in a standard single gang electrical box.

ILT - IGC

This device allows for combinations of group and individual control of up to four ILT motors. Each switch input is configurable to operate any combination of motor outputs.



Mechanical Specifications: Overall Dimensions: L: 6 in. W: 8 in. D: 4 in.

INFRARED REMOTE

An infrared sensor will connect directly to an ILT motor using 4 conductor modular cable. SOMFY's single channel transmitter can then operate any motors in range as a group.

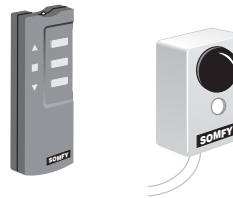

4 CONDUCTOR MODULAR SPLITTER

This device has four 4-pin modular connectors on it. It is useful for group control of multiple ILT motors from a single switch or infrared sensor if desired.



Mechanical Specifications: Overall Dimensions: L: 6 in. W: 8 in. D: 4 in.

TYPICAL APPLICATIONS

Single Motor Remote Control

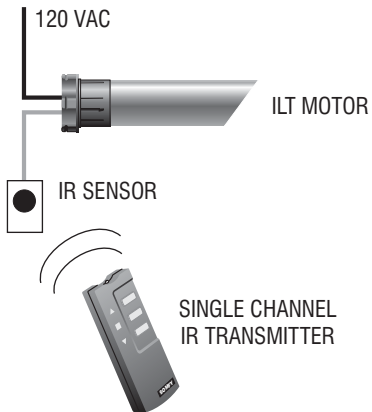

Group Only Control with a Single Switch

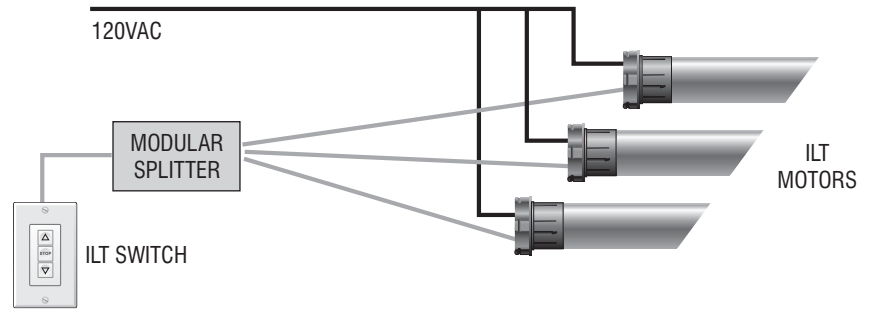

Group and Individual Control

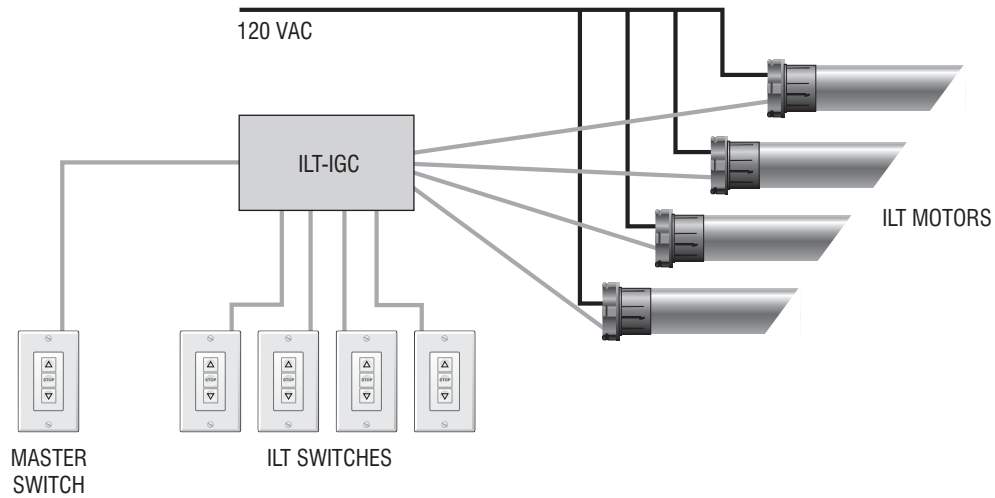

ORDERING INFORMATION

Description	Catalog Number	Description	Catalog Number
ILT Switch	6300053 (White), 6300054 (Ivory)	4 Conductor Modular Splitter	5510491
ILT - IGC Control	6300721	Single Channel Transmitter	6300879
InfraRed Sensor for ILT	6150477	4 Pin Modular Connector Crimp Tool	4600020

LON CONTROLS

DESCRIPTION

LONWorks is an international standard for building management network communications. A SOMFY ILT motor paired with a Somfy LON controller can communicate with any LON certified device. The SOMFY LONWorks System provides a flexible shading system that installs easily, is configurable without the need for rewiring, and integrates seamlessly into other building control systems.

COMPONENTS

BUS INTERFACE (BIU)

The Bus Interface Unit for ILT motors is a communication device that passes data to and from the ILT motor to switches, group controllers or other LON devices. Each BIU can control two ILT motors and provides three programmable intermediate stopping positions.

Mechanical Specifications: Overall Dimensions: L: 4 ³/₄ in. W: 5 ¹/₄ in. D: 2 in.
Electrical Specifications: Power Supply: 48V DC (from Network), 15mA
Network: Free Topology, LPT-10, 78Kb/s



GROUP CONTROL UNIT (GCU)

The Group Control Unit allows control of several ILT motors from a single switch. When connected to the LON busline, the GCU can be programmed to activate any Bus Interface on the busline.

Mechanical Specifications: Overall Dimensions: L: 4 ³/₄ in. W: 5 ¹/₄ in. D: 2 in.
Electrical Specifications: Power Supply: 48V DC (from Network), 15mA
Network: Free Topology, LPT-10, 78Kb/s



LON SWITCH

This decorator switch connects to either a Bus Interface or Group Control Unit to provide local or group operation of ILT Motors. It has 6 buttons to provide UP, STOP and DOWN operation as well as 3 programmable positions. The motor limits can also be set using the same switch.

Mechanical Specifications: Overall Dimensions: L: 4 ¹/₂ in. W: 2 ³/₄ in. D: 1 ¹/₄ in.
Installs in a standard single gang electrical box.



LON BUS SUPPLY

This is a DC power supply that maintains the LON busline

Mechanical Specifications: Overall Dimensions: L: 10 in. W: 8 in. D: 4 in.
Electrical Specifications: Input Voltage: 120V AC +/- 10%
Output Voltage: 48V DC, 0.5A



TYPICAL APPLICATION

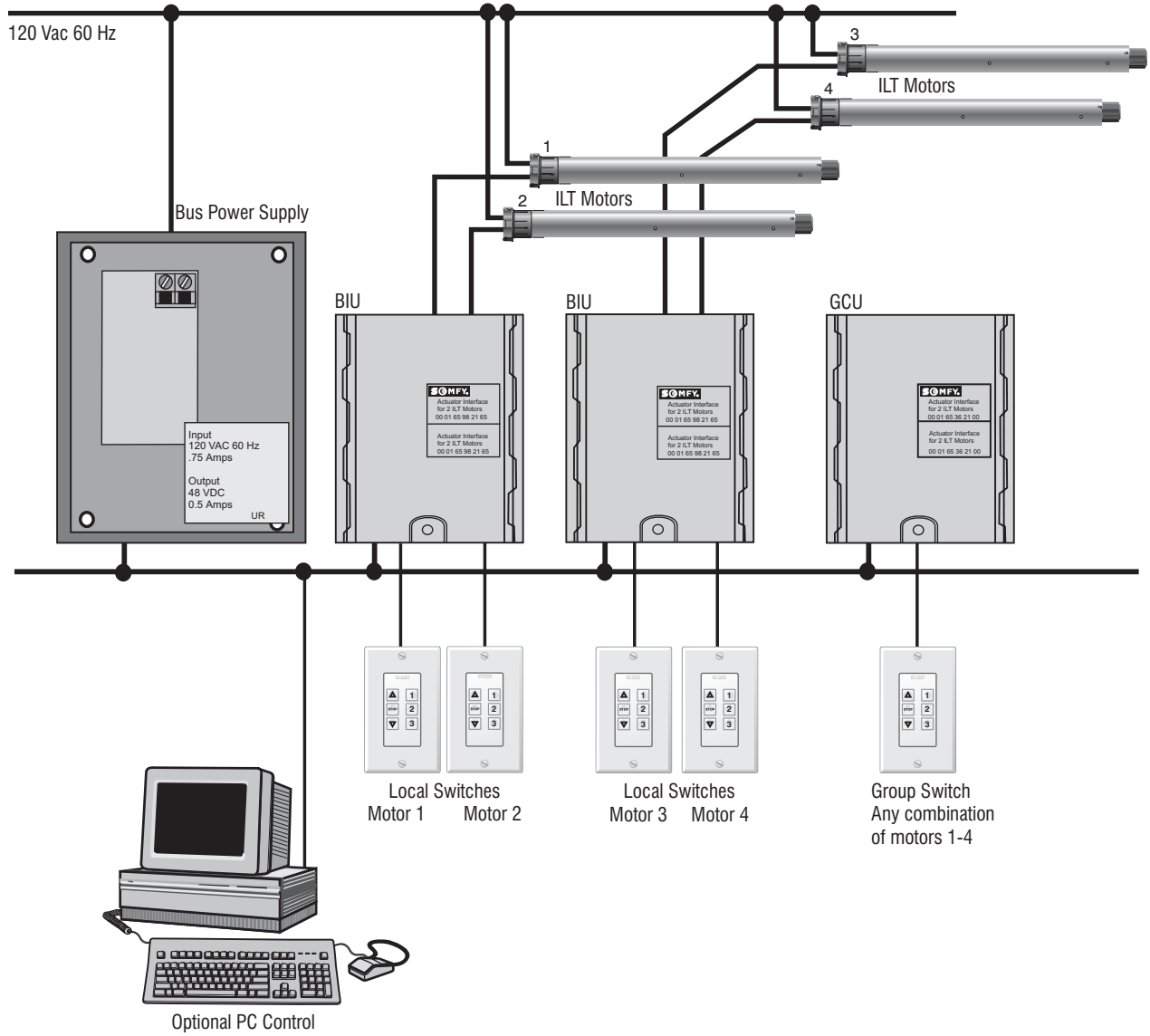

ORDERING INFORMATION

Description	Catalog Number
LON Switch	6301004 (White), 6301005 (Ivory)
Bus Interface Control	6301001
Group Control Unit	6301002
Bus Supply	6301003

SOMFY ACCESSORIES

DC TRANSFORMERS

Whenever DC motors or controls are specified, DC transformers must accompany them. Care should be taken in selecting the correct transformer for your application.

Rating	Catalog Number
12 VDC 1A	5700088
12 VDC 3A	5700091
12 VDC 5A	5700092
24 VDC 600mA	5700095
24 VDC 1A	5700093
24 VDC 1.2A	5700193
24 VDC 2.5A	5700096
24 VDC 6.5A	5700098
24 VDC 12A	5700099
24 VDC 15A	5700199
24 VDC 20A	5700200

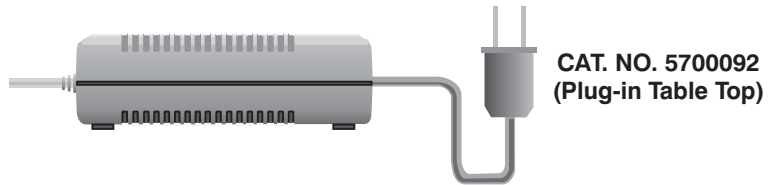

CAT. NO. 5700092
(Plug-in Table Top)



CAT. NO. 5700088
(Plug-in)

DRAPERY MOTOR CONTROLS

Description	Catalog Number
X-10 Radio Remote Control Kit	6300816
X-10 Appliance Module	6300812
X-10 Universal Module	6300747
X-10 Timer	6300815
Single Decorator Rocker Switch	6300967
Dual Decorator Rocker Switch	6300968
Decorator Switch	6301012 (White), 6301013 (Ivory)
Single Channel Infrared Remote Kit	6300876
MultiChannel Infrared Remote Kit	6300108

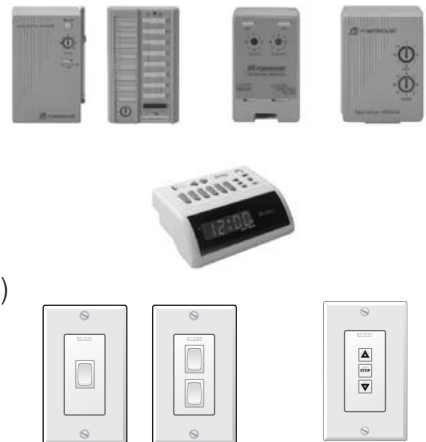

MOTOR TESTER CABLE

Before proceeding with line voltage wiring of any AC motor, the UP and DOWN limits should be set using the SOMFY Motor Tester Cable.

Description	Catalog Number
LT Motor Tester	6020086
FTS Motor Tester	6020087

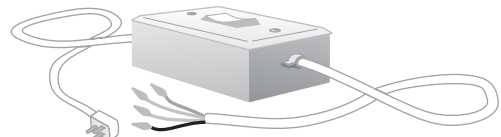

SOMFY ACCESSORIES CONT'D

MODULAR CABLE (6 Conductor)

Description	Catalog Number
Modular Cable, 2 ft., Gray	5680341
Modular Cable, 7 ft., Gray	5680278
Modular Cable, 25 ft., Gray	5680313
Modular Cable, 35 ft., Gray	5680342
Modular Cable, 50 ft., Gray	5680343
Modular Cable, 75 ft., Gray	5680345
Modular Cable, 100 ft., Gray	5680344
Modular Cable Crimping Tool (6-Pin)	4600022
Modular Cable Spool (500 ft.)	5680302
Modular Cable Spool (1000 ft.)	5680340
Modular Plug, 6-Pin	5510393
Modular Coupler, 6-Pin	5510495
Modular Tee; 1 Male to 2 Female, 6-Pin	5510496

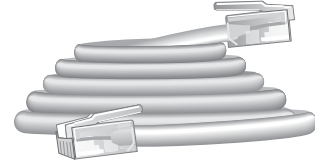

MODULAR CABLE (4 Conductor)

Description	Catalog Number
Modular Cable, 1 ft., Gray	5680401
Modular Cable, 25 ft., Gray	5680425
Modular Cable, 50 ft., Gray	5680450
Modular Cable Spool (1000 ft.)	5680404
Modular Plug, 4-Pin	5510394
Modular Cable Crimping Tool (4-Pin)	4600020

IGC TESTER CABLE KIT

This tester is used to ensure 6-pin modular connectors are correctly oriented and securely crimped onto the modular cable.

Cat. No. 6300729

ELECTRICAL BOXES

SOMFY offers masonry electrical boxes to house controls and associated wiring.

Description	Catalog Number
2 Gang Masonry Electrical Box, 3.5" Deep	5670323
4 Gang Masonry Electrical Box, 3.5" Deep	5670064
2 Gang Weatherproof Electrical Box	6110324

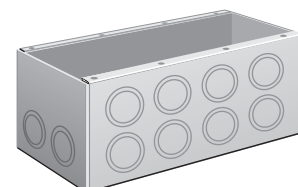
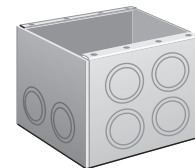

<i>3N1 Remote</i>	71	<i>ILT-IGC</i>	80
<i>Cable Tester</i>	84	<i>ILT Switch</i>	80
<i>Centralis</i>	54	<i>Infrared Switch</i>	16
<i>Chronis RTS Timer</i>	13	<i>Intellis Timer</i>	14
<i>Comfort Control</i>	42	<i>IRS300</i>	64
<i>DC-5</i>	24	<i>Key Switch</i>	20
<i>DC Transformers</i>	84	<i>LON Controls</i>	82
<i>Decorator RTS Switch</i>	12	<i>LT28 Stall Sensor</i>	79
<i>Decorator</i>		<i>MCIR</i>	60
<i>AC Switches</i>	9	<i>Modular Cable</i>	85
<i>DC Switches</i>	9	<i>Moduline</i>	35
<i>Comfort Control</i>	42	<i>Motor Tester</i>	84
<i>IGC Switch</i>	10	<i>MultiSwitch Command</i>	75
<i>Somfy Matic</i>	38	<i>Outdoor Plug-in Switch</i>	18
<i>Digital Keypad</i>	19	<i>Outdoor Somfy Matic</i>	40
<i>Drapery Motor Controls</i>	84	<i>RTS25-DC</i>	56
<i>Eolis Receiver</i>	46	<i>RTS Sensors</i>	51
<i>Eolis RTS Sensor</i>	51	<i>RTS Switch</i>	12
<i>FTS Control</i>	78	<i>RS232 Interface</i>	74
<i>GCS-II</i>	26	<i>Single Motor Remote Control</i>	68
<i>HRC-IR</i>	62	<i>Soliris Receiver</i>	48
<i>HRC-RF</i>	58	<i>Soliris RTS Sensor</i>	51
<i>IGC</i>	28	<i>SOMFY-Matic</i>	38
<i>IGC-II</i>	31	<i>SubGroup Control</i>	34
<i>IGC/3N1</i>	28	<i>Synchronizing Control</i>	76
<i>IGC-II/3N1</i>	31	<i>Telis Transmitter</i>	57
<i>IGC-DC</i>	22	<i>Telis4</i>	57
<i>IGC Switch</i>	10	<i>Telis Soliris</i>	50
<i>IGC Subgroup Control</i>	34	<i>Wind-a-Matic-II</i>	44
<i>IGC Cable Tester</i>	84	<i>Wireless Command</i>	66
